



UNIVERSITY OF
PORTSMOUTH

ESTATE MASTERPLAN

MASTERPLAN REPORT
SEPTEMBER 2016

SECTION 3 and 4

Report prepared by



and Sub Consultants



SYSTRA MAX FORDHAM



Alexi Marmot Associates



port.ac.uk

3.0 Masterplan Strategies

3.1 Strategic Overview

The following is a summary of the masterplan strategies that will form the framework for future development over the next 10-15 years.

Academic Zoning

The masterplan has identified opportunities for gathering subject areas together, based on the existing Faculty structure and building on the success of the consolidation of the Faculty of Creative and Cultural Industries within the Eldon Building. This will help to create a more coherent campus with greater identity for each academic area.

Development Strategy

The existing building stock has been assessed against a set of agreed criteria and categorised in relation to potential for redevelopment, refurbishment, remodelling or disposal. This provides a clear picture for where the significant development opportunities exist within the existing campus.

Accommodating growth

The capacity of potential development sites has been established. This has been set against the area requirements to accommodate targetted increased student numbers, ambitions for increased academic growth and support services such as improved sports provision. This illustrates the significant potential for additional area within the existing campus.

Building Design Strategy

The masterplan defines outline footprints and massing for individual buildings which have been based on an atrium building typology. This typology provides for flexible buildings that can accommodate a range of spaces types in close proximity, and facilitate a greater degree of visual connections between different parts of the building, providing the opportunity for a more collaborative learning culture.

Public Realm Strategy

The quality of the public realm is key to creating a campus that has coherence, character and provides safe and enjoyable routes and spaces around the campus. The public realm strategy sets out the principles of routes, nodes and character and illustrates a few specific examples.

A sustainable campus

An Energy and Sustainability masterplan has been developed as an integral part of the overall masterplan and covers both the existing estate and proposed development. Reducing energy consumption, Wellbeing (creating buildings and public realm that are a pleasure to be in) and Engaging academic expertise to drive innovations in sustainability are the University's high priorities.

Highways

To support the public realm strategy and to develop solutions to the existing conflicts between pedestrians and traffic, we have included some specific Highways projects as part of the masterplan. It is anticipated that these projects would be realised by or in partnership with the City Council.



3.0 Masterplan Strategies

3.2 Academic Zoning

Locations of different academic areas have developed incrementally and on an adhoc basis over time as the University has grown. This has resulted in certain Faculties being fragmented across the campus, in particular the Faculty of Humanities and Social Sciences is distributed across a number of buildings at the far reaches of the campus.

The recent investment into the Eldon Building and White Swan Building has resulted in the consolidation of the Faculty of Creative and Cultural Industries, with the exception of Music Technology which remains in its own building in Middle Street.

The masterplan provides the opportunity to strengthen the identity of each of the Faculties by creating a zoning of subject areas, giving the campus a greater coherence and enabling the development of themed hubs.

The diagram opposite illustrates how this rationalisation and consolidation could take shape.

Portsmouth Business School

Located within a new building on Victoria Park site, shared with Humanities and Executive Suite

Faculty of Humanities and Social Sciences

Located within Park Building and part of new Victoria Park Building, with existing space relocated from St George's Building. Further consideration is to be given to the further relocation of HSS spaces currently within Milldam and Ravelin House.

Faculty of Technology

Located within new and existing buildings within Liongate Terrace area (inc Richmond Building vacated by Business).

Faculty of Science

Located within existing buildings on Anglesea Road but with the potential for future growth within the Northern Quarter.

Faculty of Creative and Cultural Industries

Located within Eldon and White Swan Buildings with potential in future to also relocate Middle Street facilities within Eldon.

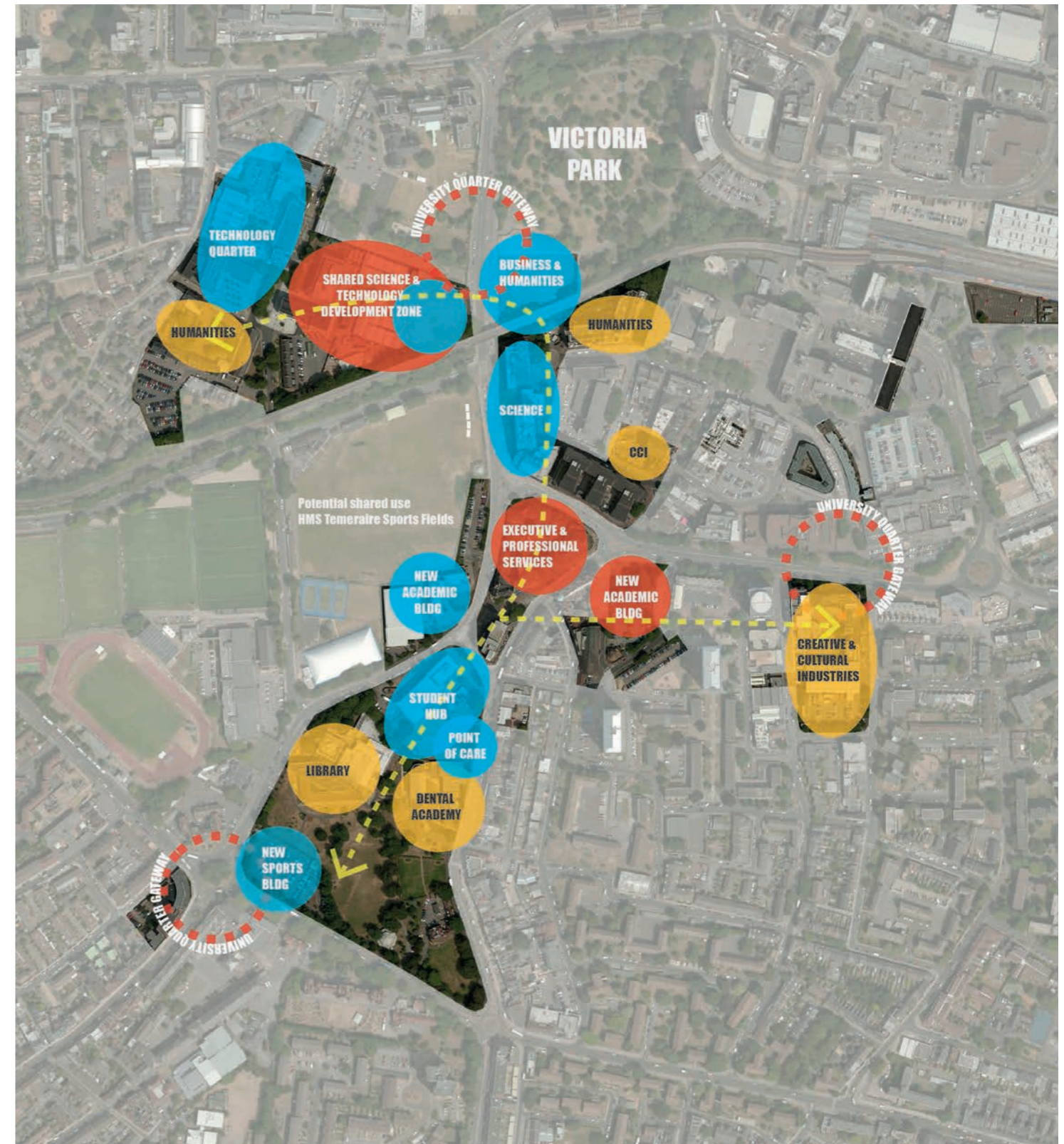

3.0 Masterplan Strategies

3.3 Development Strategy

The existing University buildings have been assessed using a set of criteria as follows:

Fitness for Purpose

Adaptability

Identity

Future Potential

Development Options for each building range from no immediate change (ongoing maintenance) through to demolition or site disposal summarised as follows:

No change - building in good condition, fit for purpose and contributes positively to the campus - ongoing maintenance/light refurbishment only.

Minor refurbishment - building in good condition but needs reorganising internal spaces to create spaces and layout that meet the masterplan objectives - may include structural alterations to open up connections between floors.

Major Refurbishment/Remodelling - building in poor condition but could be given a new lease of life by stripping back to frame and recladding, with potential major remodelling.

Demolition - building in poor condition, no longer fit for purpose and compromises wider masterplan objectives - demolition and rebuild.

Disposal - surplus to requirements and no benefit in retaining.

Using the above criteria and in consultation with the University the plan opposite illustrates the development strategy across the City Centre campus.

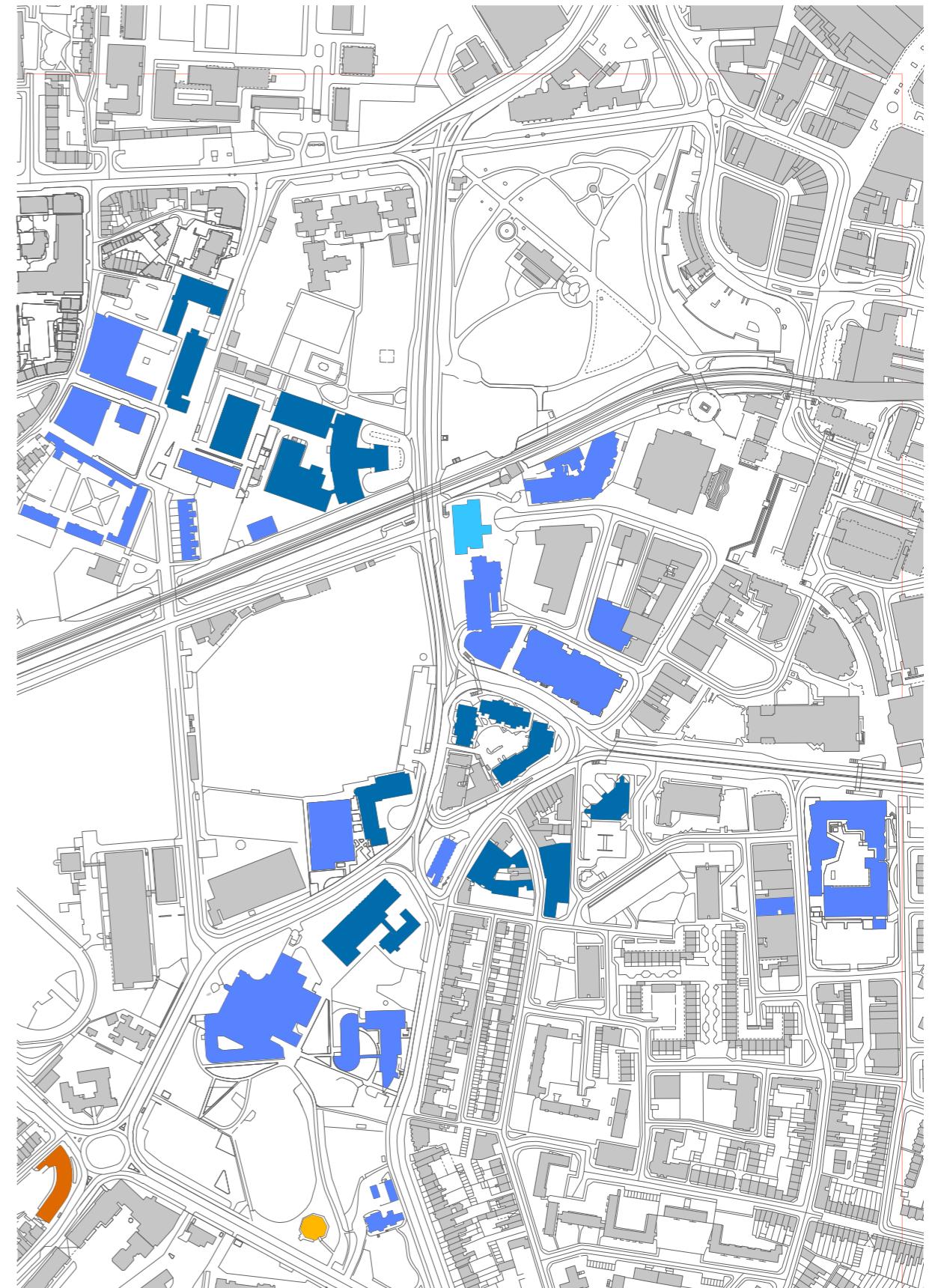
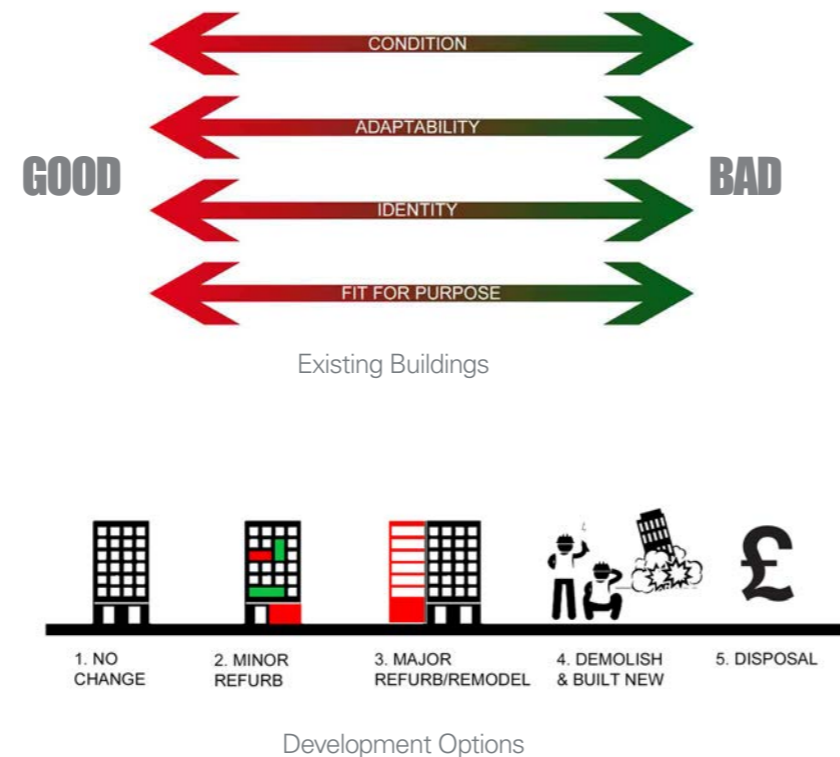

3.0 Masterplan Strategies

3.4 Accommodating Growth

The diagram opposite illustrates the potential additional capacity of the various sites around the campus.

The figures in orange represent existing GIA and figures in white represent the potential total GIA after redevelopment. Across the whole campus this equates to a total potential additional GIA of approx 60,000m². This is far in excess of additional spatial requirements for the period of the masterplan, but demonstrates that the existing campus does have significant growth potential.

To meet the student growth targets for 2020/21, set out within the University Strategy, an additional approx 15,000m² would be required, not taking into account any increase in efficiency in existing space utilisation. The Northern Quarter alone (including the Victoria Park site) would potentially provide approx 25,000m² of additional GIA. This is the most significant development opportunity for increasing academic space within the masterplan period.

Beyond the student growth targets identified within the University Strategy, long term ambitions include potential growth within Healthcare including Dental School, Nursing and Point of Care facilities. The immediate spatial requirements for the first intake of nursing students has been met by converting part of St Andrew's Court. This is however seen as a temporary measure and the Northern Quarter provides the opportunity for a permanent solution to be developed.

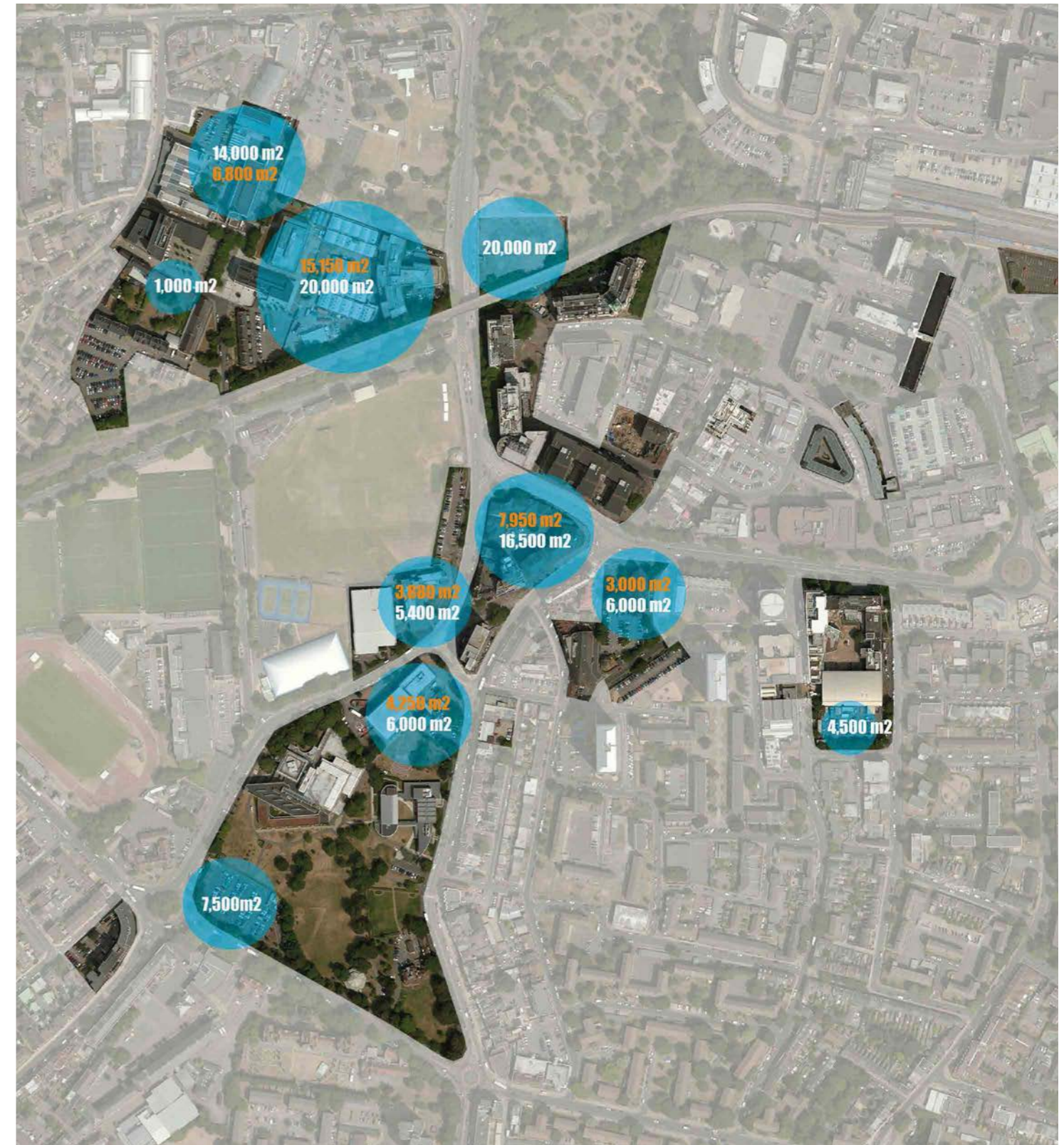

3.0 Masterplan Strategies

3.5 Building Design Strategy Building Organisation

Many of the existing University buildings are shallow plan with double loaded corridors running down the centre, such as the Buckingham Building. This typology creates an inward looking environment, with little interaction between spaces or sense of identity.

For the purposes of the masterplan we have adopted an atrium building typology wherever possible. A deep plan atrium building has the following advantages:

- The atrium itself provides good levels of visual interaction between different spaces in the building, promoting a more collaborative learning culture.
- The atrium can provide greater visibility from the outside into the heart of the building, generating a curiosity about the activities within.
- The atrium building provides greater potential to provide a range of size of spaces, enabling generic learning spaces, specialist teaching spaces, social learning spaces and academic offices to all be in close proximity to each other.



01

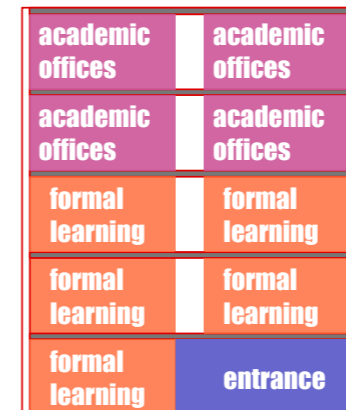

Shallow plan corridor building

02



03

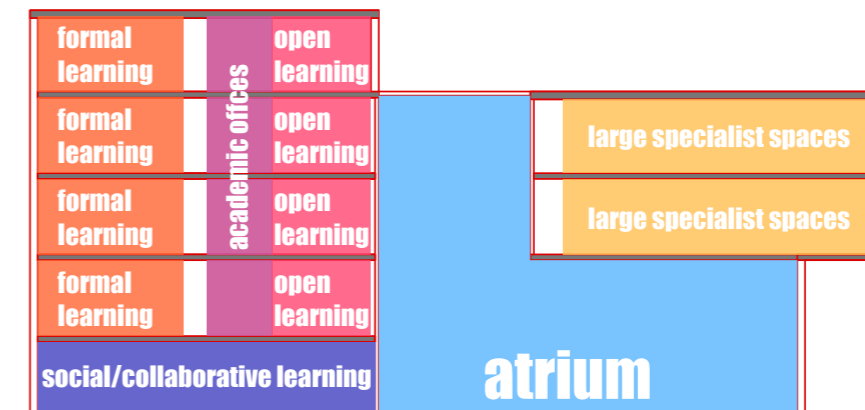

Deep plan atrium building

04

- 01 Buckingham Bldg - example of existing corridor building
- 02 Corridor building diagram
- 03 Lancaster Technology Building atrium building precedent
- 04 Atrium building diagram

3.0 Masterplan Strategies

3.5 Building Design Strategy Height and Massing

Proposed building heights have been determined with respect to surrounding context, including location of Conservation Areas and Listed Buildings.

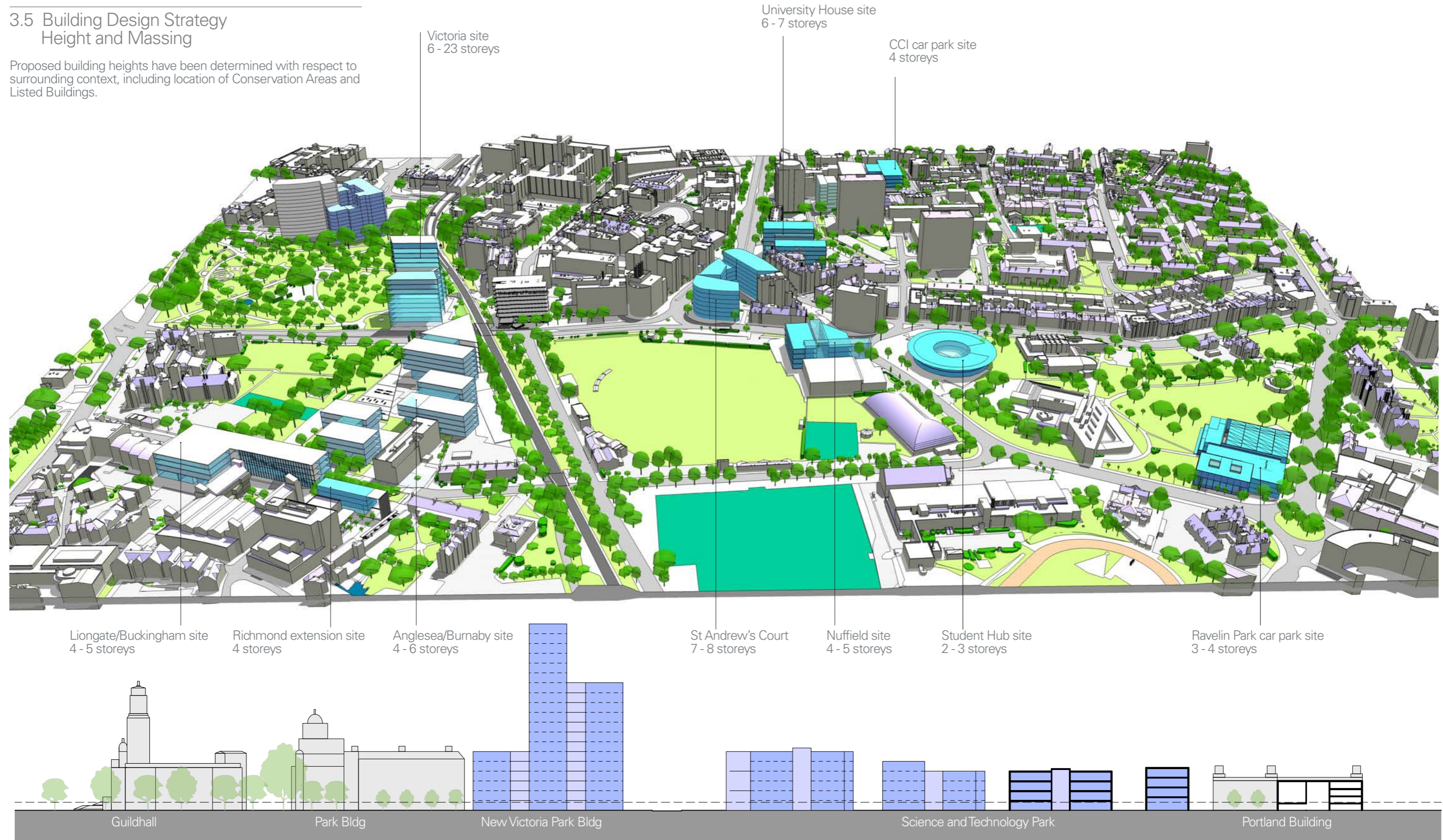

Section through Northern Quarter

3.0 Masterplan Strategies

3.5 Building Design Strategy Materials Palette

The existing palette of materials around the campus is partly informed by the different periods of construction.

Predominant materials include stone cladding, dark red brickwork, white render, pre-cast concrete panels, zinc cladding, curtain walling.

For the purposes of the masterplan, we have suggested a limited palette of materials, but with various treatments or construction methods that might be applied to add variety and interest.

Following on from the building design strategy, the unifying feature of each of the new academic buildings might be an expressed frame, which is then filled to suit the building's function, adapt to different internal requirements for light, ventilation, privacy, and respond to its immediate context.

Overleaf are three examples of a consistent frame structure being treated in various ways.

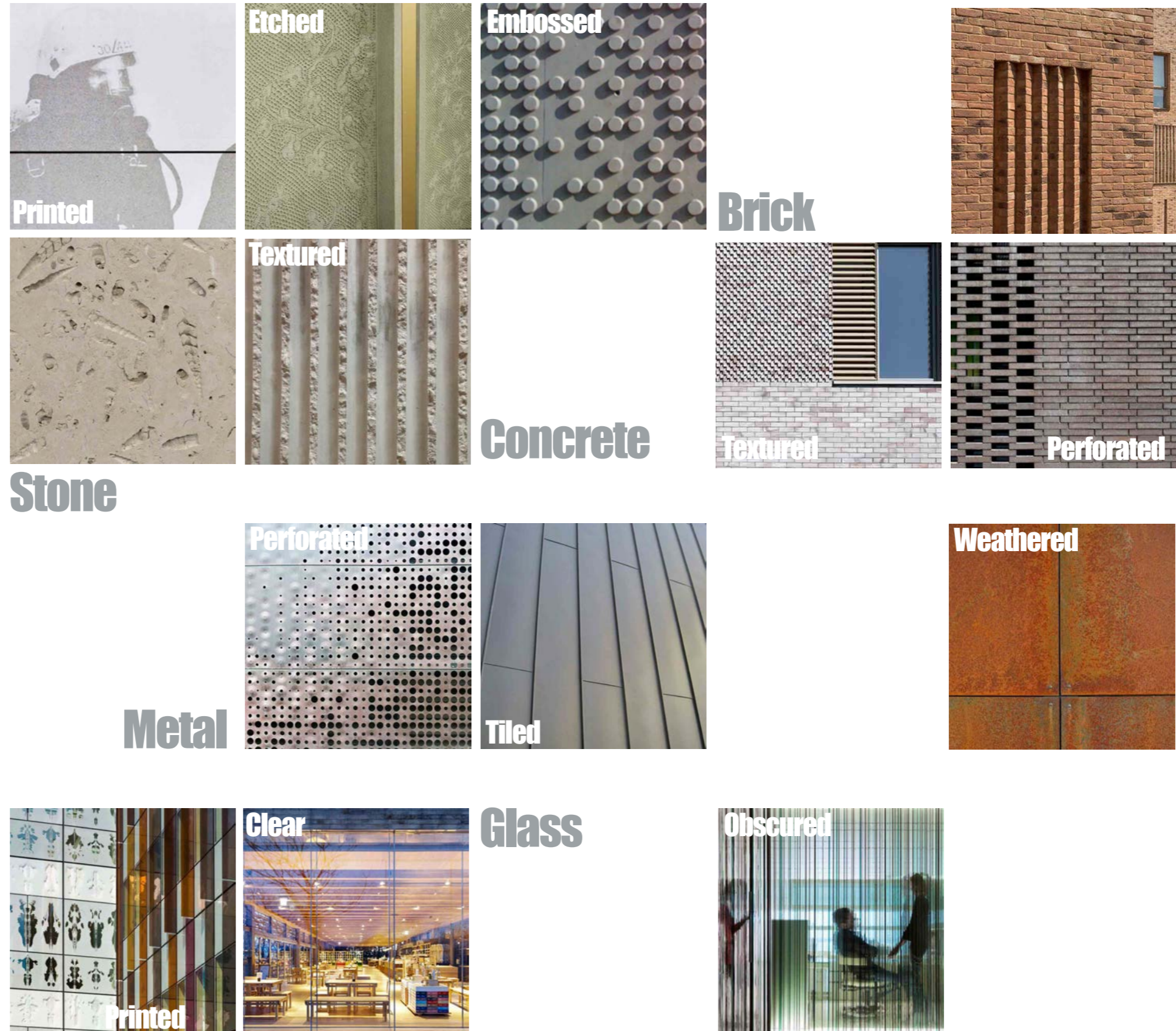

3.0 Masterplan Strategies

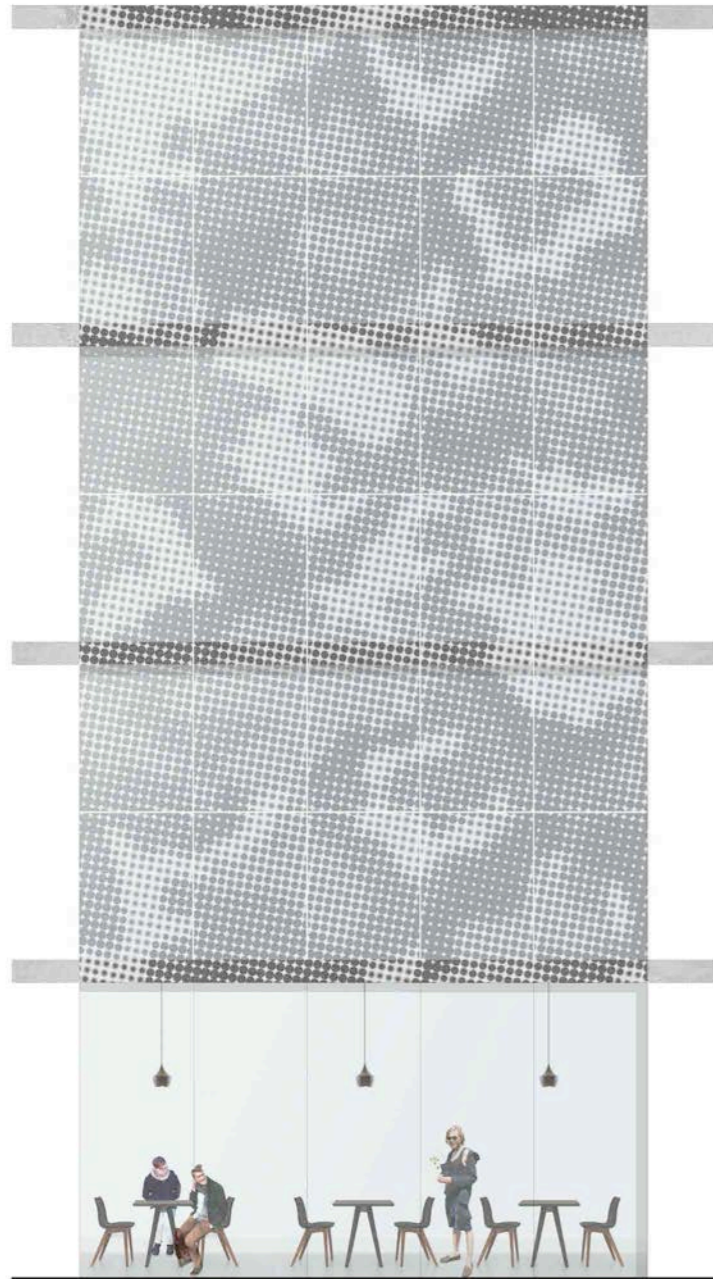

**printed
glass**

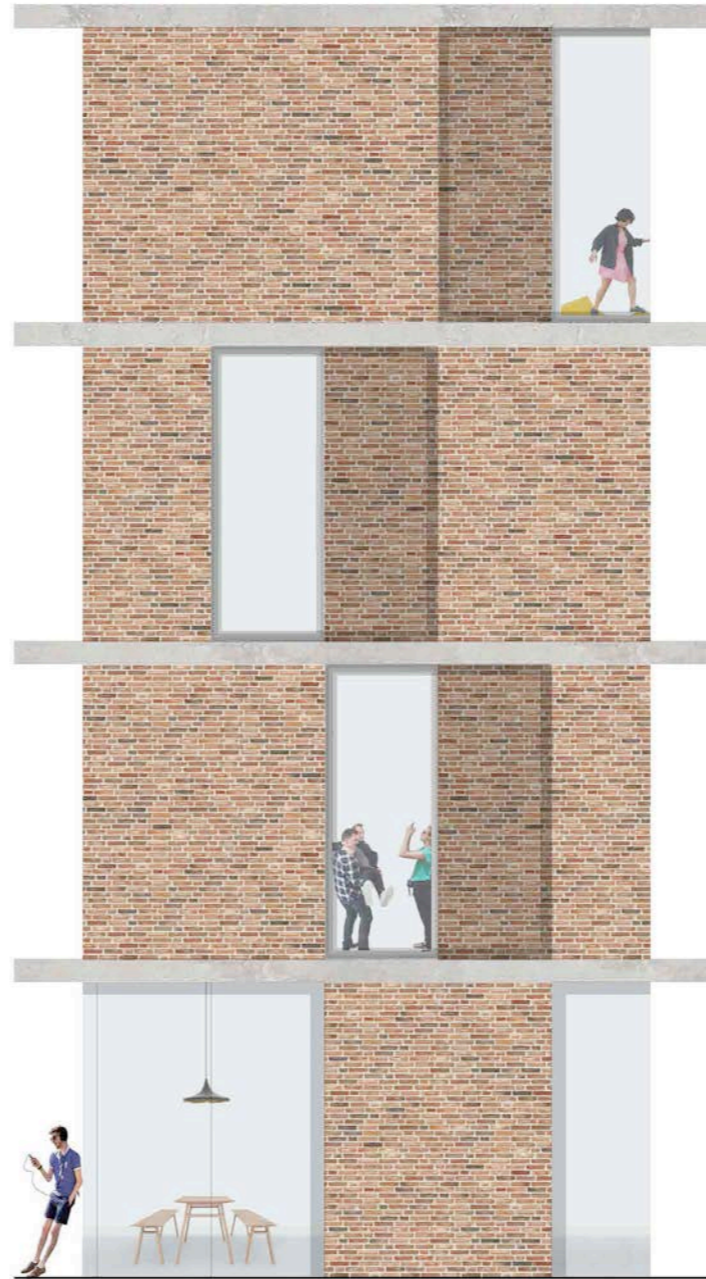

**brick
panels**

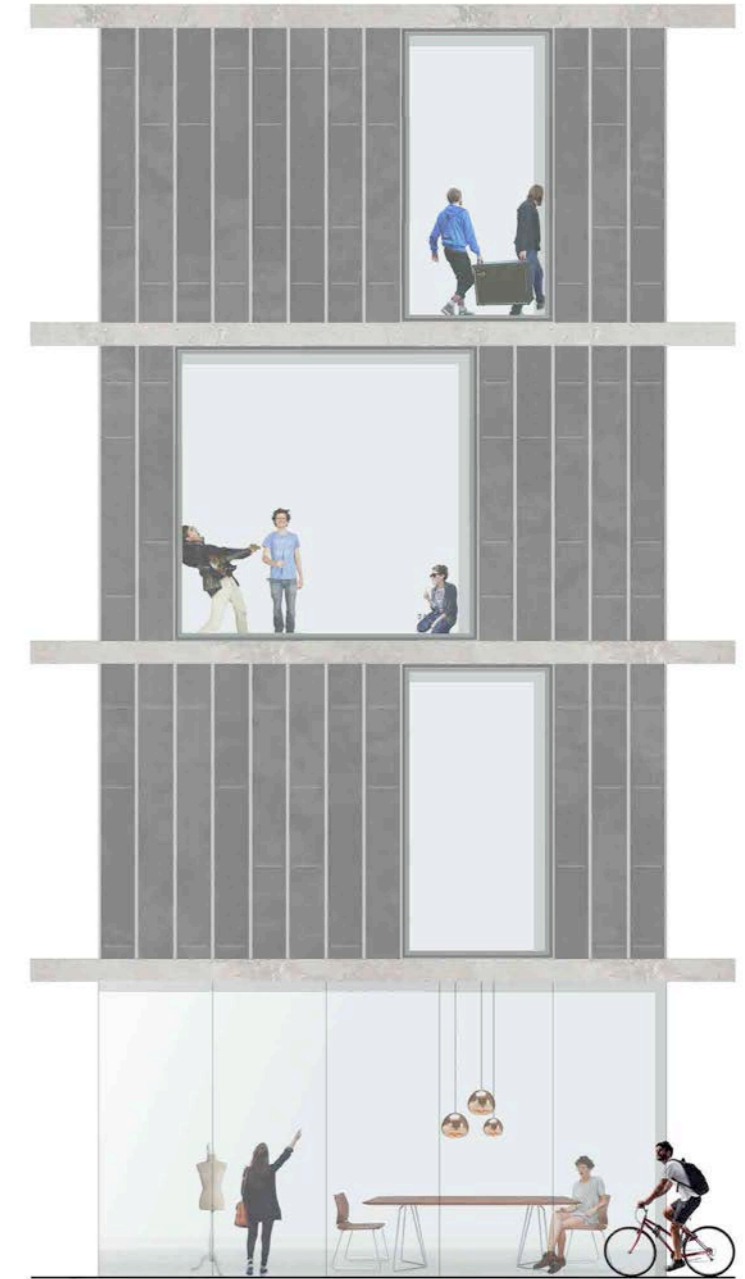

**metal
cladding**

3.0 Masterplan Strategies

3.6 Public Realm Strategy Character Zones

The central campus can be divided into four character zones, helping to define an approach to the public realm.

A The Northern Quarter - Courts and Alleys

The existing public realm is characterised by a mix of courtyard spaces, alleys, and undefined leftover space between buildings. The strategy includes reconfiguring the area to create coherent network of courtyard spaces, with a clear separation of service access and pedestrian flow.

B Victoria Park - Public Park

The open setting of the Park provides the opportunity to create a public realm around the new building that helps to integrate University and City domains and provide a setting for a landmark building.

C Central Quarter - Road Edges

The area around the centre of the campus is characterised by proximity to major roads which serve to divide the area. The strategy includes creating improved routes and creating active, incidental public spaces along highways.

D Ravelin Park

Ravelin Park serves as the main student hub with buildings organised as a series of pavilions set within the park. The public realm strategy would seek to retain and enhance this quality by providing small hard spaces close to buildings for intense use, with grassed areas preserved and new and existing trees helping to retain the park setting.



01



02



03



04



- 01 Richmond Building Courtyard
- 02 Victoria Park
- 03 Winston Churchil Avenue
- 04 Ravelin Park

3.0 Masterplan Strategies

3.6 Public Realm Strategy Campus Gateways

The central campus can be considered to have three gateways which signal the entrance into the University Quarter. This gives the opportunity to celebrate and enhance the presence of the University in the City.

A Anglesea Crossing

Gateway framed by two new University developments (Victoria Park site and Anglesea site) with views down Anglesea Road towards Ravelin Park.

B Winston Churchill Avenue

Eldon Building forms the eastern gateway to the University campus. The public realm along the south side of Winston Churchill Avenue could provide a new University boulevard linking Eldon, Trafalgar House, University House and St Andrews Quarter, and celebrating the presence of the University..

C Cambridge Road

A new sports building at the southern end of Ravelin Park would provide a new southern gateway to the campus. The sports building, library and student hub would create a sequence of University buildings that could be united by an improved public realm along the east side of Cambridge Road



- 01 North Gateway - New Victoria Park Bldg on Anglesea Road
- 02 West Gateway - Eldon Building with new public realm on Winston Churchill Avenue
- 03 South Gateway - New Sports Building on Cambridge Road

03

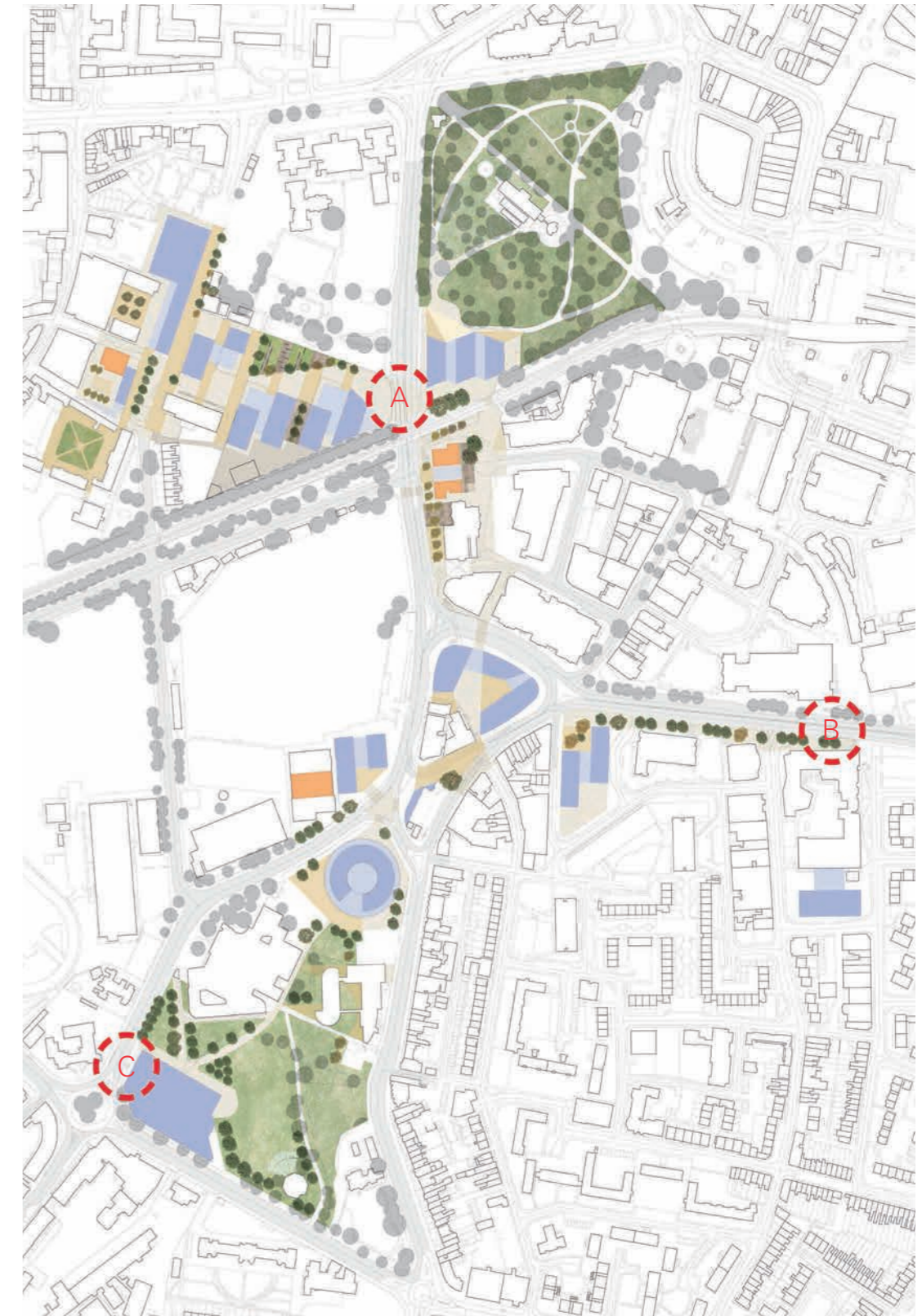

3.0 Masterplan Strategies

3.6 Public Realm Strategy Routes and Nodes

The public realm strategy will create a coherent network of safe pedestrian routes around the campus. These routes will be articulated by ground floor activity nodes, some existing, some new, that help to identify the University presence and create activated public space.

The functionality of these nodes may change depending on the specific context, including social spaces, learning spaces, display spaces and study spaces. The success of the Library refurbishment and the fact that it is now beyond capacity, creates a particular need for additional informal learning spaces distributed around the campus.

- 1 New Technology Building
- workshops on show
- 2 Dennis Sciama
- existing hub spills into public space
- 3 New Business School
- exhibition space at ground
- 4 St Andrews Quarter
- new development at the centre of the campus with new social hub at the centre
- 5 Eldon Building
- existing gallery and event space activates eastern edge of campus
- 6 Student Hub
- campus route passes through the new Student Hub creating a natural gathering place
- 7 Sports Centre
- new Sports Centre with open generous foyer/cafe space marks the southern edge of the campus



01



02

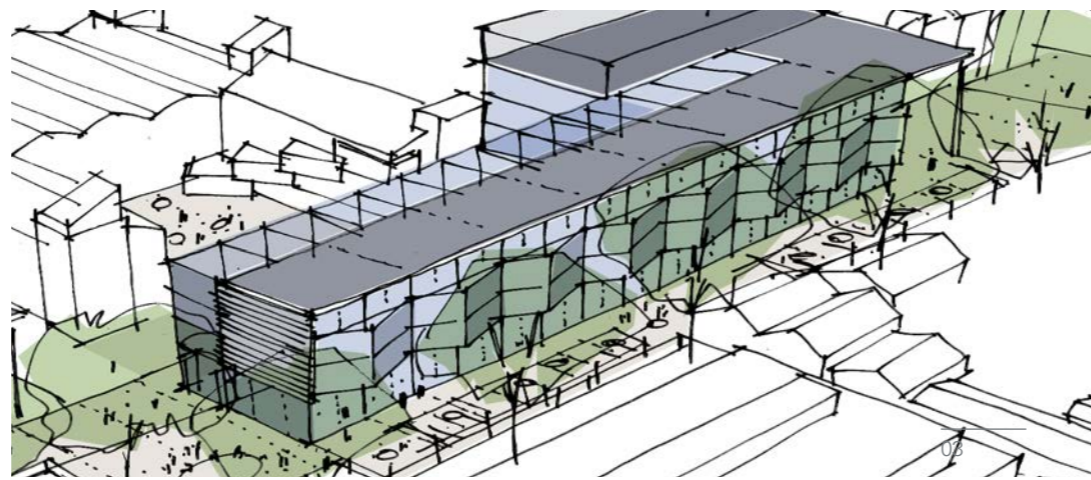

03



04

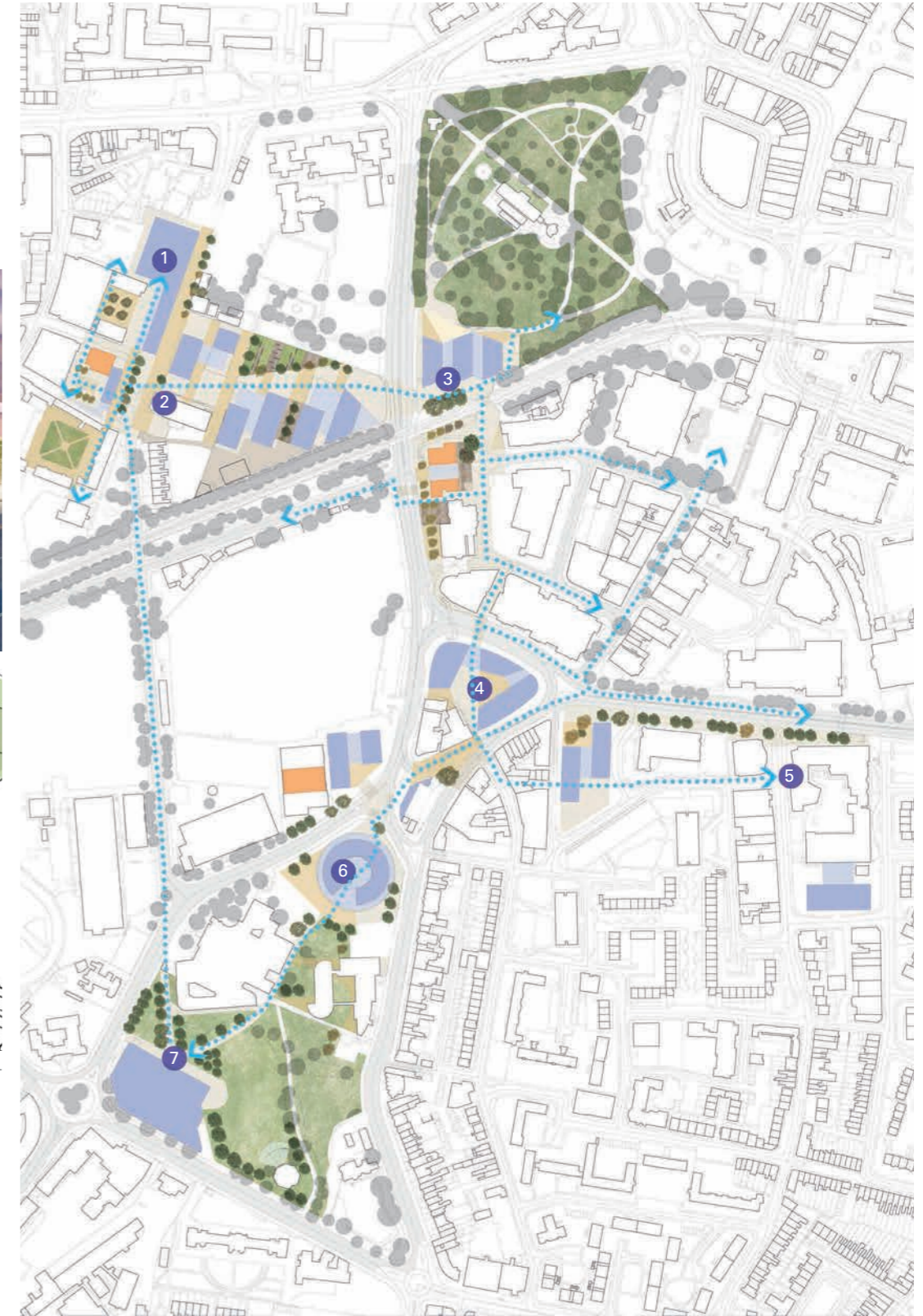

- 01 Eldon Building
- 02 New Business and Humanities Building
- 03 New Technology Building
- 04 Student Centre

3.0 Masterplan Strategies

3.6 Public Realm Strategy Active Ground Floor

By adopting the principle of an active ground floor throughout the campus we create the opportunity for places for display, for collaboration, impromptu discussion, engagement with the wider community, provoking curiosity about what goes on in the University. This would inform a strategy not only for buildings and how they engage with the outside world at street level, but also for the public realm that creates the connectivity between all buildings.

The public realm is not only animated by the activities within buildings but through considered design can accommodate a range of activities and functions in its own right.

In developing a strategy where the public realm and ground floor of University buildings play a part in creating a campus that is accessible, exciting and full of activity, the following aspects will need to be considered:

- Access and Security Strategy
- Hard and Soft Landscaping Strategy
- Lighting Strategy
- Public Art Strategy
- Wayfinding Strategy
- Curated Exhibition/Display Spaces



Large shared spaces at ground floor for mix of uses



Social spaces distributed throughout the campus with mix of catering offer



Enclosed meeting rooms spaces

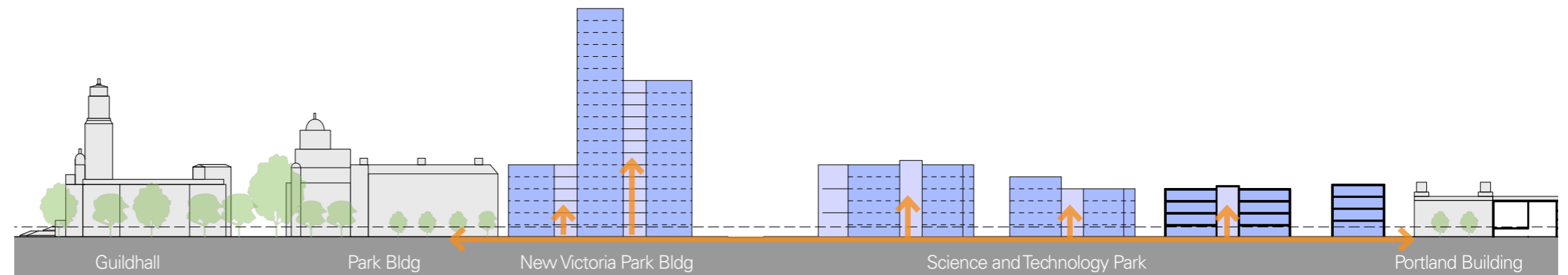

Active ground floor extends into atrium buildings



Diagram of campus with active ground floor

3.0 Masterplan Strategies

3.6 Public Realm Strategy Anglesea Court

The redevelopment of the Anglesea site provides the potential to create a significant new public open space, creating a clear route from Victoria Park, through the Northern Quarter to the western edge of the campus on Portland Street. The space would be a mix of hard and soft landscaping with places to relax, study and socialise. This would be an important route not only for the University community but also for the wider public, helping to further integrate the University in the City and celebrate the activities within.



01

- 01 Plan of space
- 02 Aerial View
- 03 Precedent images



02

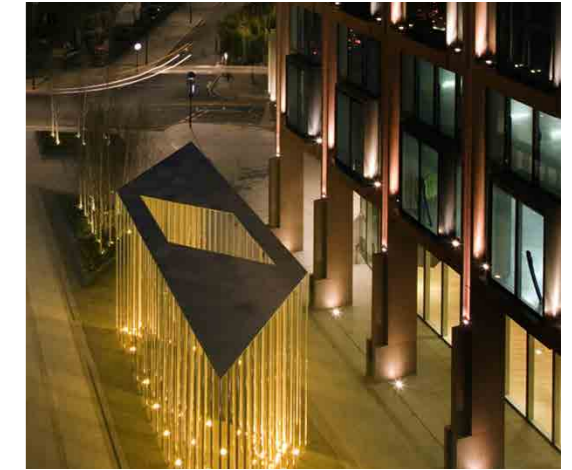

03

3.0 Masterplan Strategies

3.6 Public Realm Strategy Lion Terrace and Richmond Square

Portland Street currently fragments the external space between Dennis Sciama and Richmond Buildings. By incorporating a shared surface, or rerouting the traffic, a central square can be created at the heart of the Technology Quarter. with the New Technology Building, Dennis Sciama and Richmond extension accessed from and opening onto this new space. Shade is provided by the existing boulevard of trees, and additional street furniture and lighting can be provided to create a safe and usable space. The Richmond extension opens onto and encloses the Richmond Square, which can become a very different space, focussed on external study, with shading, green walls and seating to provide an attractive, usable and inviting space.



01

- 01 Plan of space
- 02 Aerial View
- 03 Precedent images



02



03

3.0 Masterplan Strategies

3.6 Public Realm Strategy Cambridge Road

Cambridge Road is a busy, traffic bound thoroughfare, but the opportunity exists to create visual links through towards Park Building and the civic centre, by remodelling the lower levels of the King Henry Building. In conjunction with a new pocket park with green walls and new seating between St Michael's and King Henry buildings, this will alleviate the current sense of enclosed, dead space along Cambridge Road.



01

- 01 Plan of space
- 02 Aerial View
- 03 Precedent images

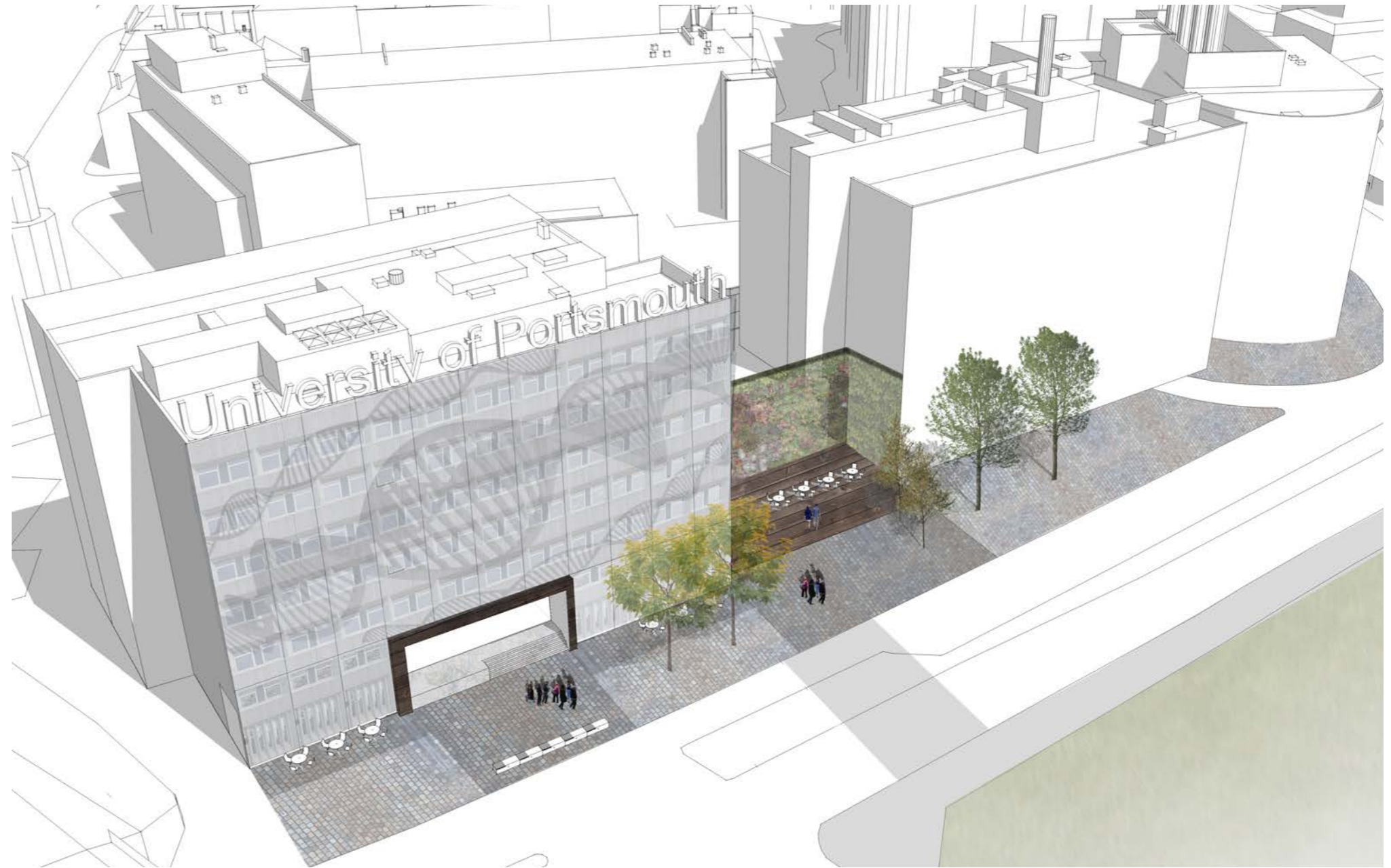

02

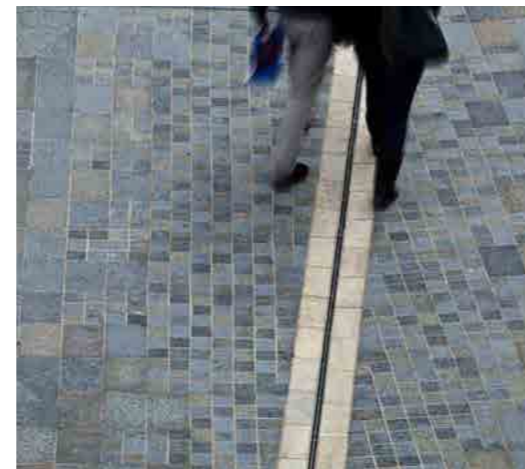

03

3.0 Masterplan Strategies

3.6 Public Realm Strategy Winston Churchill Avenue

Winston Churchill Avenue forms the western gateway into the University Quarter and is currently defined by the dual carriageway. By incorporating public realm works along the southern side of the road, a greater importance can be given to the pavement area providing places to sit, potential for artwork, new lighting and tree planting. A shared surface at the access into Middle Street would also help to define a continuous pedestrian zone that connects Eldon back to the centre of the campus.



01



02

01 Plan of space
02 Aerial View

3.0 Masterplan Strategies

3.7 Teaching and Learning

The success of University buildings in supporting and engendering a more collaborative approach to teaching and learning is not simply in the range of spaces that are provided, but the organisation of those spaces and key adjacencies.

The Building Design Strategy considered the advantages of an 'atrium' type building typology for new University buildings, more public spaces on the ground floor, increasing privacy as you move up through the building, visibility up and across the atrium visually connecting the various activities and functions.

The diagram opposite illustrates a hierarchy of spaces that might similarly be used to begin to organise new academic buildings on the campus.

Each building is connected to the main student route, with a clearly visible and inviting foyer style entrance. At least one collaborative lecture theatre type space is included near the entrance to promote students gathering, sharing ideas, discussion. This space leads onto seminar and teaching spaces, which are supported by academic offices. Specialist spaces are included in the mix, located to suit their functional requirements. The central idea is a radial set of adjacencies with a collaborative space at the centre.

The following pages look at some examples of innovative teaching and learning styles in HE institutions both in the UK and abroad. The intention is to provide a starting point for discussions around brief development for any new academic building progressed within the masterplan.

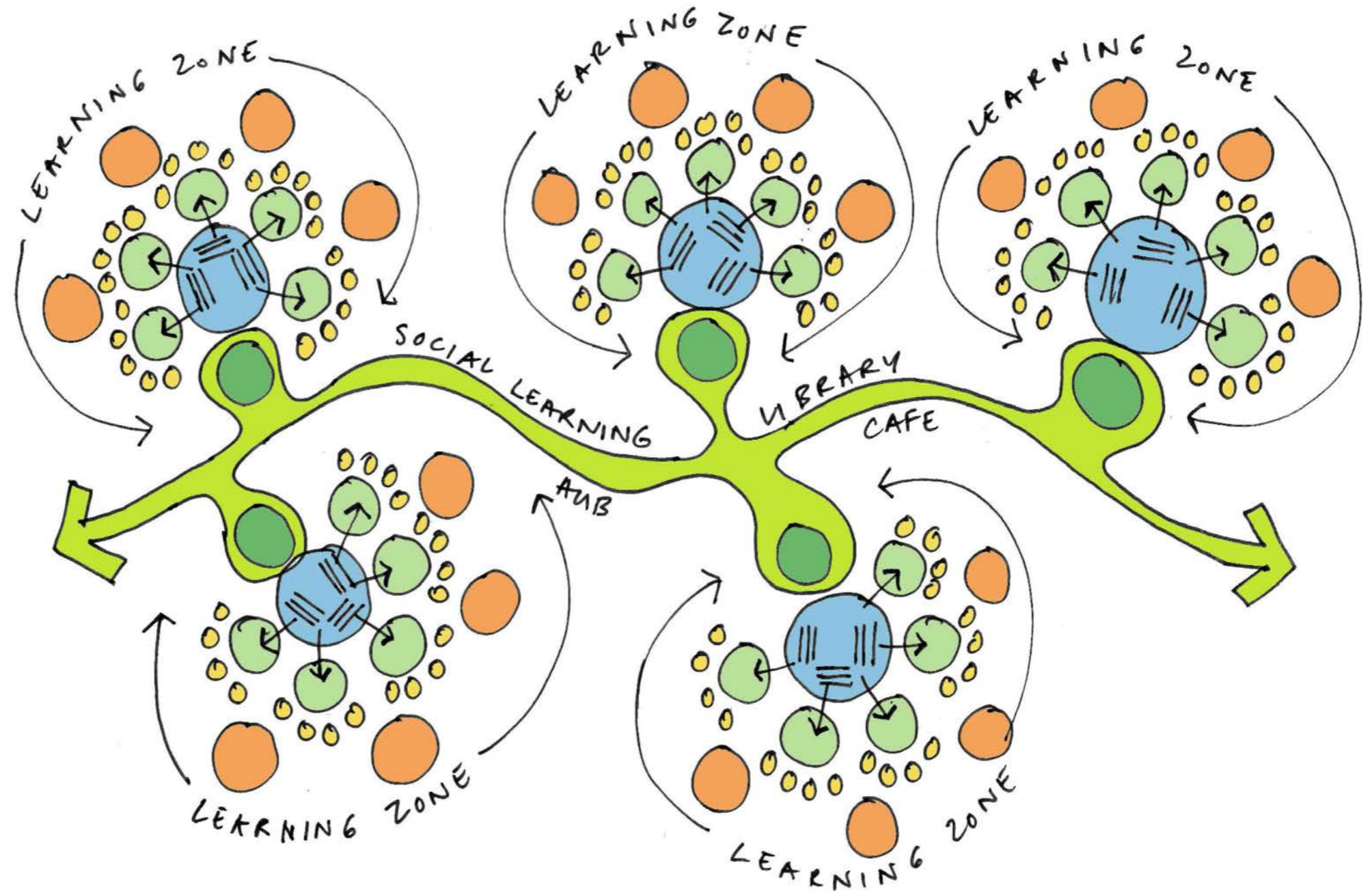

3.0 Masterplan Strategies

3.7 Teaching and Learning

The following teaching and learning precedents are intended to promote further conversation with UoP stakeholders with regards provision and design of teaching and learning spaces within the masterplan. The paper considers:

- 1 Drivers for change in the design of teaching and learning spaces
- 2 Implications on design of teaching and learning spaces
- 3 A few case studies to illustrate how other HE institutions have evolved new teaching and learning spaces
- 4 Translating to University of Portsmouth masterplan

The following quote from the Horizon Report 2015 HE Edition summarises current and evolving thinking in the HE sector:

Some thought leaders believe that new forms of teaching and learning require new spaces for teaching and learning. More universities are helping to facilitate these emerging models of education, such as the flipped classroom, by rearranging learning environments to accommodate more active learning. Educational settings are increasingly designed to facilitate project-based interactions with attention to mobility, flexibility, and multiple device usage. Wireless bandwidth is being upgraded in institutions to create "smart rooms" that support web conferencing and other methods of remote, collaborative communication. Large displays and screens are being installed to enable collaboration on digital projects and informal presentations. As higher education continues to move away from traditional lecture-based programming and to more hands-on scenarios, university classrooms will start to resemble real-world work and social environments that facilitate organic interactions and cross-disciplinary problem solving.

Shift to a knowledge driven economy with less emphasis on factual knowledge and greater emphasis on the ability to think critically

Shift from tutor as 'sage on stage' to 'guide on the side'

More tailored approach with greater range of learning styles to accommodate different ways of learning

The impact of technology on learning styles and spaces

Shift from a teacher centred approach to a student centred approach

Increasing diversity of student populations

Need to optimise space utilisation and efficiency

Shift towards more collaborative learning style

Shift to student as customer making choices based on based on physical campus environment and facilities

3.0 Masterplan Strategies

3.7 Teaching and Learning

A student-centered approach to education has taken root, prompting a rethink in how learning spaces should be configured. The traditional classroom has evolved to accommodate new pedagogies; instead of the traditional rows of chairs with writing surfaces facing a podium, universities are creating more dynamic classroom layouts, often with seating arrangements that foster collaborative work. These redesigned spaces support what is often referred to as flexible or active learning. While active learning spaces vary, they share many common features. The typical podium is moved from the front of the classroom to the centre and is surrounded by round or oval tables with movable chairs that enable students to shift between groups as needed. Each table may be technology-enabled, with interactive whiteboards or other marking surfaces.

A broader range of Lecture theatre styles have also evolved, facilitating pedagogic ideas such as the 'flipped classroom', promoting active and collaborative learning, such as at Loughborough University.

This shift is also requiring universities to examine how informal campus environments can be modified to become theatres for learning. Casual spaces in high-traffic areas such as lobbies, atriums, and hallways are being designed so that they can become locations where students congregate and work more productively. They often feature comfortable furniture, power outlets for charging mobile devices, and LCD monitors for connecting laptops.

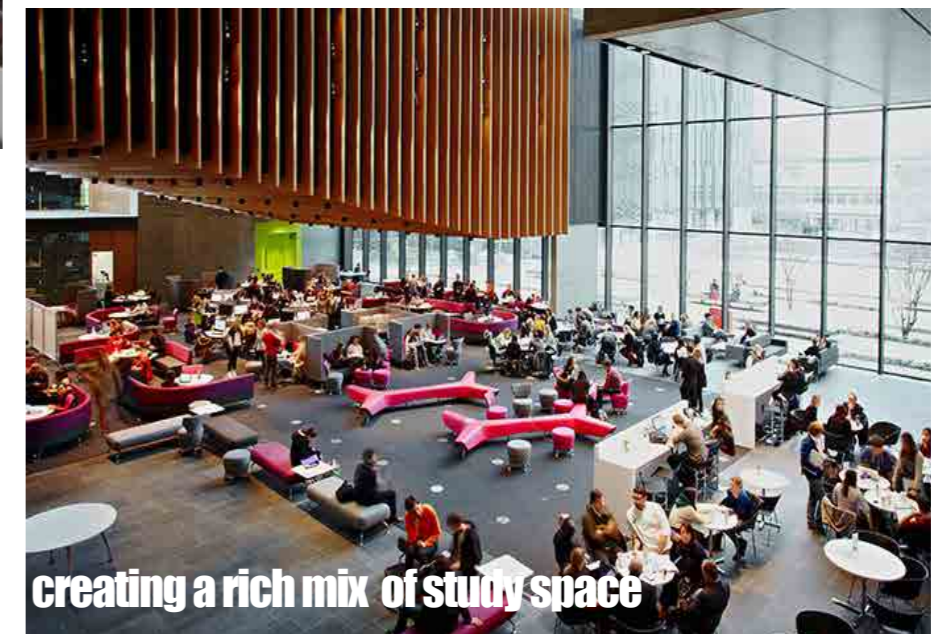
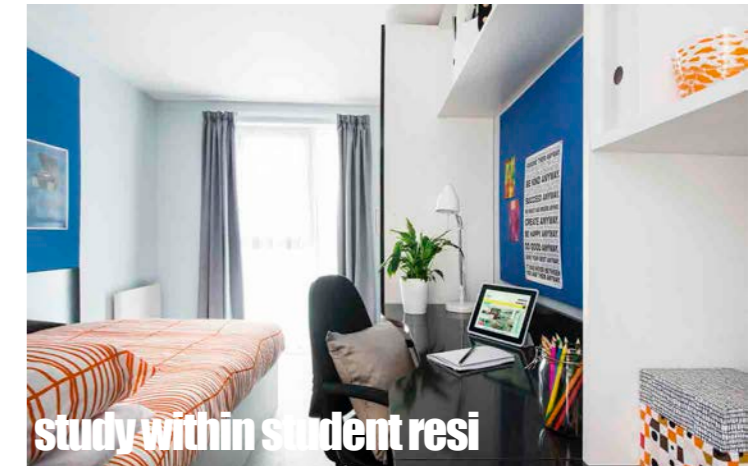
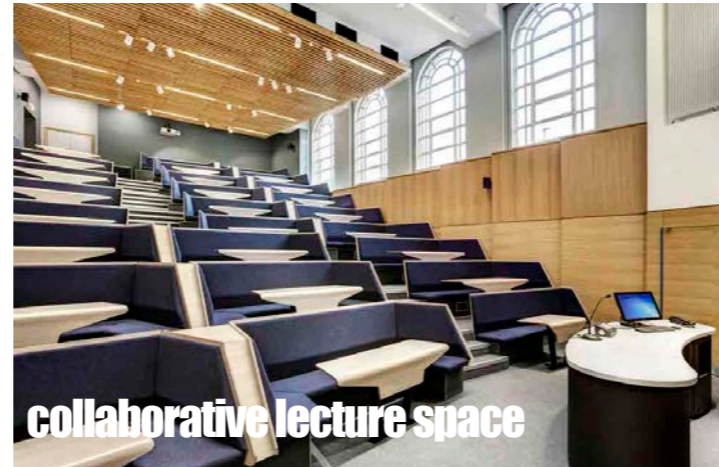

3.0 Masterplan Strategies

3.7 Teaching and Learning Sir John Cass Business School

The Cass Business School is research-intensive international school with approx 2,800 overwhelmingly postgraduate students who study exclusively in a new building.

The building has seven floors plus a basement, and arranged around two relatively small atriums, one four stories high and the other six stories, designed to provide light and to support the natural ventilation systems, whilst also providing visual connections into a mix of teaching and learning spaces.

The building houses the full, self-contained range of administrative, academic, research, and teaching and learning functions.

The lower ground floor houses two flat floor 60-seat classrooms with a fold-down flat-screen computer beneath every desktop. A 180-seat auditorium which is used intensively for large classes and, particularly in the evenings, business conferences and events.

A reception area outside the auditorium is one of the most flexible multifunction spaces in the building and is used for refreshments and exhibitions.

The ground floor contains a raked, or sloping, 80-seat classroom and a high-technology securities-dealing room sponsored by Bloomberg. With its glass wall, the classroom has high visibility from the reception area.

The middle floors of the building are dominated by two types of space. First, there are a dozen lecture rooms for up to 80 people, generally based on the Harvard principle of debate and interaction between lecturer and students in a U-shaped layout. Second, a series of large and small break-out areas, located in the floors and galleries of two atria, extend the learning process beyond the formal teaching spaces in a way that animates the school as a whole. Elsewhere, the lower levels contain a learning resource centre, café and a 200-seat lecture theatre, whilst the upper floors are devoted to offices for academic staff, a restaurant and a suite of rooms for executive teaching.

The first factor in the building's success is the diversity of the spaces. Creating such diversity was a key result of the research project that preceded the architectural design.

...the building has not only been a very positive feature in terms of student recruitment and in improving our overall image in the City, but has been very supportive of academic staff recruitment and retention; the internal spaces promote the types of collaborative working methods we sought, as well as allowing for a very diverse range of private and semi-private spaces.

Professor Clive Holtham, Professor of Information Management, Cass Business School

The single most powerful influence came from the San Marco Monastery in Florence, since almost every configuration of its space is optimized to support and stimulate knowledge work. The Cass Business School does not look like a monastery, but its design reflects a similar diversity and quality of knowledge space.

The whole building is based on principles of flexibility and transparency, reflecting the values of the Sir John Cass Business School.

...high-tech, high-touch building.

This clarified that almost every space would provide staff and students wired access to the Internet and offer opportunities for non-technology-based face-to-face interaction.

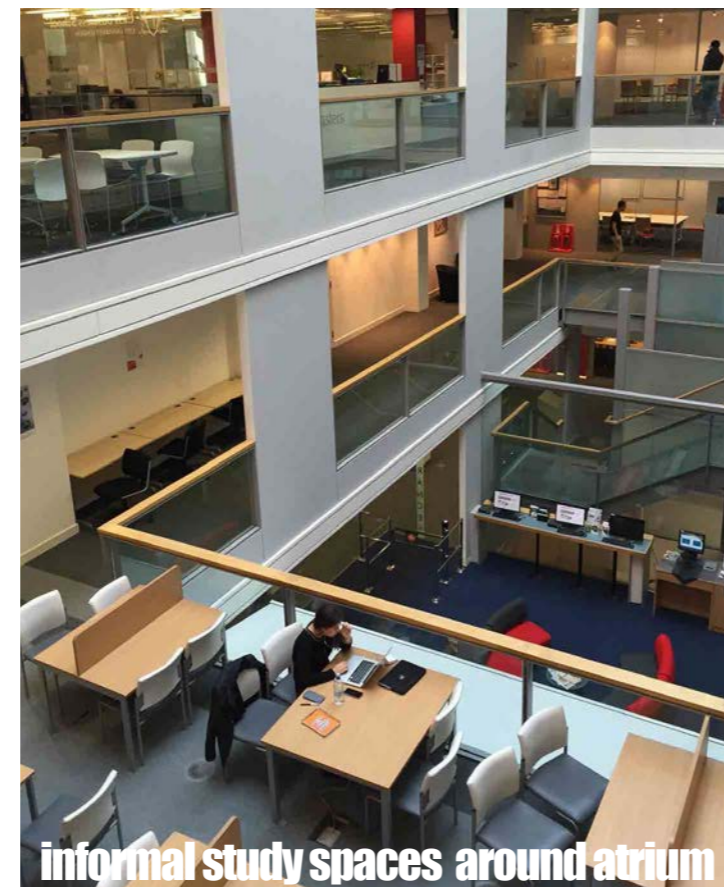

informal study spaces around atrium



main foyer



raked 80 seat classroom



main auditorium



individual study spaces

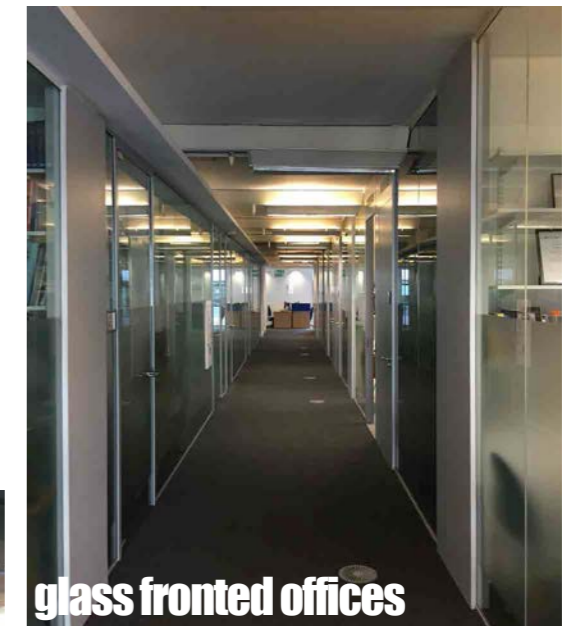

glass fronted offices



third party sponsored spaces

3.0 Masterplan Strategies

3.7 Teaching and Learning University of Queensland

The University of Queensland is one of Australia's leading broad-based, research-intensive universities and is committed to the excellence of learning experiences and outcomes for its students.

A key objective of the University is to provide a high-quality learning environment that encourages independent learning and peer-to-peer interaction. To meet this objective, the University has invested in new teaching and learning spaces that are recognised as international benchmarks for excellence and innovation.

This award-winning Collaborative Teaching and Learning Centre (CTLC) has attracted worldwide interest with groups from Europe, the United States, the Middle East, South Africa and Asia visiting to study its unique learning concepts.

The Collaborative Teaching and Learning Centre

Large Spaces

Each of the large collaborative spaces can be used as a single seminar room or can be divided into five separate and distinct 'pods' or self-contained group working spaces.

The audiovisual control systems in the room facilitate three distinct modes of operation, which support different kinds of teaching and learning and allow swift transitions between modes.

Individual Mode

The default mode is 'Individual' which effectively allows the space to operate as a Learning Commons. Large tables and benches along with freely reconfigurable seating provide space for up to ninety students to work individually or as part of groups.

The student-to-PC ratio in the large collaborative spaces is deliberately set at around 3:1, which encourages collaboration.

Seminar Mode

A teaching session will often start by selecting 'Seminar' mode which allows the teacher to address the whole group to define the tasks and provide background information. Engaging 'Seminar' mode sets off a train of events using motorised blinds, lighting changes and audio cues which re-orient students' attention to the lectern at the front.

Pod Mode

To facilitate group work, 'Pod' mode is engaged. This physically divides the room into five separate and distinct working spaces, complete with projection and sound systems under the students' control to facilitate group interactions. Again, motorised blinds, electric screens, lighting changes and audio cues make the transition overt, almost theatrical and set the scene for a different phase in the teaching session. Each 'Pod' can also be monitored and shared from the lectern.

There are two large projection screens in each room that ensure clear sight lines everywhere in the room.

The technology and facilities in the large collaborative rooms enable each of the three modes and support collaboration in teaching and learning practice.



large spaces

3.0 Masterplan Strategies

3.7 Teaching and Learning University of Queensland (continued)

Small Spaces

Configured for 25 students and 40 students, the small collaborative spaces also have the ability to split into three pods, but are not physically separated.

PC workstations are spread around the walls on a single, continuous bench. Students can work at the benches or form groups at the three large curved pod tables. Student work from each pod is displayed on large plasma monitors fixed to the walls, instead of the projection screens used in the large spaces. The output from any pod may be selected for display on the main projection screen for discussion with the whole class.

External Focus

The video-conference room can be configured to present from the lectern to a remote audience; to allow a remote presenter to interact with an audience in the room or to allow for group-to-group remote interactions based around the central pod table. Control of the Videoconference functions is possible either from the lectern or the Pod.

Eight student PC stations are provided on benches around the periphery of the room. A sliding wall allows the Videoconference and Access Grid rooms to be joined with the small collaborative spaces and this is sometimes opened to allow for larger groups such as the Peer Assisted Study Sessions (PASS). Pod mode is commonly used for these occasions with tutors roaming the space and making use of the group presentation facilities.

Space

As part of the idea that the environment of space can have a direct affect on the process of teaching and learning, two different room types were developed. The larger rooms were seen as active noisy spaces. These rooms are predominantly white and light with the ability to moderate the space through lighting and screens. The other space is more introverted 'quieter' space which is timber clad and warm with an organic, less structured feel. The technology however is similar in how it can be enabled.

Technology

The audiovisual elements within each of the spaces needed to be comprehensive, as it was recognised that elements such as videos, pictures and even sounds were often valuable in sparking creative collaboration. It was also important that the space did not become totally computer-centric. The PCs should be there to help focus the learning, and not to be the focus of the experience.

Ongoing evaluation

The University of Queensland is committed to undertake systematic evaluation and review of the evolution and operation of the St Lucia CTLC and new CLCs as they are built across the other campuses. To this end the University is putting in place a comprehensive management strategy to promote, embed, manage and evaluate advanced teaching spaces.



small collaborative space

small spaces



video conferencing suite

external focus

Loughborough Uni

Burwell Deakins Connect Lecture Theatres

Lecture Theatres at the recently completed Design School in Loughborough have been designed with bespoke furniture by the architects Burwell Deakin to facilitate collaborative work within the structure of a lecture.

Each bench accommodates 6 students with slight indents at each end to provide for the didactic teaching style to be interspersed with group discussion and learning without moving to a different space.

Whilst this would increase the area per student, the utilisation of the space would be increased by accommodating different learning styles.



collaborative lecture theatre 1

This image shows an alternative arrangement where group work zones are accommodated on the edge of the main lecture seating. This would only work as a quiet study space when the lecture is in progress.



collaborative lecture theatre 2

3.0 Masterplan Strategies

3.7 Teaching and Learning Translating into the University of Portsmouth masterplan

This diagram illustrates a pattern of teaching and learning spaces that could be applied across the campus. It is a simplified, generic set of adjacencies that would need to be adapted to suit specific requirements within different subject areas or 'learning zones'.

The campus is connected by an active ground floor which for each learning zone is registered as a foyer/exhibition space.

The focus for each of the learning zones are the large teaching and learning spaces; lecture theatres, large collaborative seminar spaces etc. These then open onto seminar spaces, possibly with audio-visual connection to lecture theatre to enable larger groups to engage with lead lectures.

Academic offices are adjacent to seminar spaces and the outer ring comprises specialist spaces such as labs and workshops.

A successful HE learning environment is one in which not only each space works hard to accommodate current and emerging pedagogy, but the adjacencies of different space types support the activities in each space.

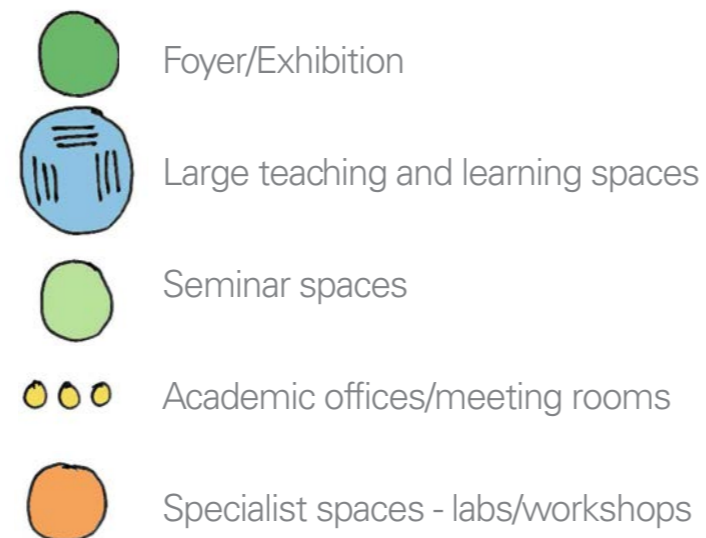
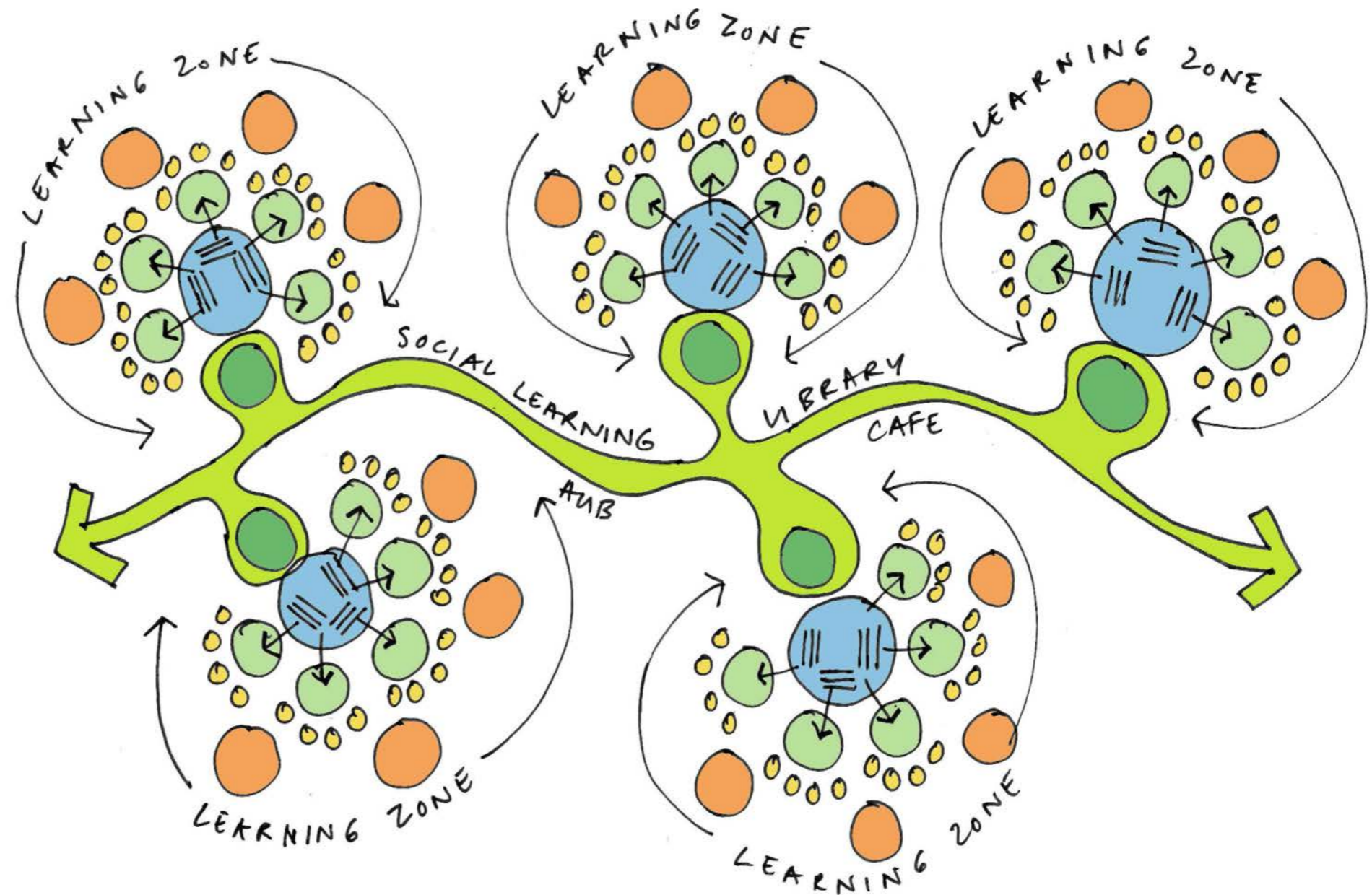

3.0 Masterplan Strategies

3.8 A Sustainable Campus

Max Fordham were appointed under ArchitecturePLB to provide energy, sustainability and services infrastructure advice to support the masterplan. A brief summary of the full report is included below.

The scope of Max Fordham's work comprised the following main pieces of work:

- understand the existing estate in terms of services and energy performance
- develop strategic proposals for services infrastructure to support the masterplan
- develop energy and environmental sustainability strategies to support the masterplan

Carbon Reduction

HEFCE set benchmark targets for carbon reduction which equate to a reduction of 43% by 2020 and 83% by 2050 set against a base year of 2005.

The University considers reducing energy consumption (within the control of the University) a higher priority than reducing carbon emissions (affected by factors beyond the control of the University). This is reflected in the energy metrics used within the report.

Sustainability Priorities for UoP

HIGH PRIORITIES	<p>Reducing energy consumption</p> <p>Wellbeing – creating buildings and public realm that are a pleasure to be in</p> <p>Engaging academic expertise to drive innovations in sustainability</p>
MEDIUM PRIORITIES	<p>Reducing carbon emissions</p> <p>Sustainable sourcing of construction materials</p> <p>Travel – enabling use of public transport, walking or cycling</p> <p>Water</p> <p>Greening the city</p>
LOWER PRIORITIES	<p>Ecology – ecological value of the city-centre estate is low and likely to remain so, however the University is keen to safeguard any existing ecological value at its sites</p> <p>Waste – the university has already made significant progress in reducing waste</p>

Existing Estate

The University's estate comprises a range of buildings some of which perform reasonably well, some less so. The overall energy consumption and carbon emissions per square metre of the University's estate is absolutely typical for a UK university; if the whole estate had a single DEC it would be a D, that is to say, slightly better than average for a university.

Recommended steps towards achieving HEFCE targets

1. **Optimise** the performance of the existing estate through enhanced energy saving policies and a planned programme of minor refurbishment works and upgrades
2. Carry out **major refurbishment**, with a particular focus on energy saving, of existing buildings which perform poorly in terms of energy but are otherwise sound and fit for purpose
3. Replace existing buildings with **new buildings which have excellent energy performance** and sustainability credentials
4. Use **energy from low-carbon sources** which are robust to future changes in energy policy and infrastructure

The report makes a number of recommendations for how energy savings can be achieved both through the management of existing systems such as zonal controls for out of hours use, and through various interventions such as sub metering presence detection on air handling and cooling units.

The following buildings are identified as candidates for major refurbishment that could significantly contribute to energy savings and the measures that should be considered for each building:

- Spinnaker Sports Centre
- King Henry and St Michael's
- Library
- Dental Academy

New Buildings

New buildings and major refurbishment projects need to be procured with a focus on excellent performance in use, not just on paper, and with the benefit of experience of how to get this to happen.

The masterplan needs to set an outline building brief in order to ensure that the new buildings genuinely deliver excellent performance. The proposed brief includes:

- Ambitious energy use target – DEC A in use
- Define a methodology for making decisions about energy and cost
- Set a BREEAM target, or equivalent, to cover other areas of sustainability
- Prioritise passive design
- Prioritise simplicity and avoid 'green bling'
- Require building heating to conform with overall UoP strategy for heat
- Include full Soft Landing services in procurement

IT Strategy

To meet the ambitious energy targets proposed it will be necessary to look hard at energy use associated with the equipment in buildings, as well as the fixed building services. For the University's buildings, the equipment is principally IT.

A low-energy IT strategy is therefore a vital element of achieving a DEC A.

The report makes recommendations as to how this might be achieved.

Impact of Masterplan

The report assesses the potential impact of the masterplan projects on the University's energy consumption.

The combined effect of all the energy-saving interventions and refurbishments, the masterplan projects and the changes to the halls on the University's energy consumption. The reduction of energy consumption, characterised by equivalent electricity, to 46% of the 2005 baseline is very significant and is the most that can be achieved within the timescales of the masterplan in terms of improving the energy efficiency of the estate. In order to make further energy savings, it is the sources of energy used by the University that would need to be considered.

Infrastructure to support the masterplan

The peak load on each of the three UoP HV rings will remain within the total existing capacity of the transformers on those rings so other considerations aside, the rings and their substations should be able to support the new developments they would be expected to serve.

However the Northern quarter is going to be extensively redeveloped, so while there is sufficient capacity on the existing ring for the masterplan developments (even if the ring is extended across Anglesea Rd to serve the new Business and Humanities building), the existing substations and HV intake are unlikely to be in the right locations for the new developments, so we should assume that a phased replacement of all the Northern quarter electrical infrastructure will be required, with the number and location of substations decided to suit each plot as it is developed.

Energy Sources

The final section of the report looks at the energy sources available to the University and how these might affect the masterplan.

For existing buildings the report concludes that at present there is no clear cut best option between retaining gas boilers, switching to electric and connecting to a heat network, so all those options should be kept open – perhaps carry out a feasibility study for converting an existing building to electric heating with thermal storage, and stay involved in discussions about the Portsmouth heat network with the aim of directing it towards a low-carbon heat source – and in the meantime to take all available opportunities to reduce the heating demand of the existing buildings.

The pros and cons of a range of on-site renewable energy sources are discussed including:

- Biomass Boiler
- Solar Thermal Hot water
- Anaerobic Digestion
- Photovoltaic (PV) Cells

The report concludes that photovoltaics are the most suitable renewable technology for integration into the new buildings of the masterplan. It is anticipated that the use of PVs on roofs of new buildings will need to be maximised to help achieve the DEC A target in any case, so PVs on the new buildings is implicit in the energy targets.

Biomass and solar thermal may make sense for the Sports Centre only, to help reduce the heating load to be met by gas for this building, as heat pumps only will not provide sufficient heat to meet the pool and shower loads. This will need to be assessed as part of the development of the design for the Sports Centre to achieve the DEC A target.

3.0 Masterplan Strategies

3.9 Highways Anglesea Road Pedestrian Crossing

Staff and students that wish to access the Anglesea building and other University buildings further west from the eastern side of Anglesea Road currently use the pedestrian crossing facilities provided at the junction of Anglesea Road and Park Road. This signalised junction provides a controlled crossing on each arm of the junction and the crossing on the northern arm of Anglesea Road is frequently busy with students crossing to the Anglesea building.

The junction operates a pedestrian phase at the signals which allows all pedestrian crossing movements while the traffic signals are held at red, but those that begin crossing late in this phase can become stranded on the refuge area in the centre of the carriageway. The numbers of stranded pedestrians can be such that the refuge cannot accommodate them and they spill onto the carriageway as a consequence. This creates a risk of conflict between pedestrians and vehicles once the traffic signals turn to green, and the Portsmouth City Council Highways Department is seeking to address this issue through implementing a revised junction layout with the crossing on the northern arm removed.

Development of the Victoria Park site to provide a Business School with lecture theatres and seminar spaces will introduce an increased demand for the crossing of Anglesea Road as students move to and from the new facility from the Anglesea building side of the campus.

In order to meet this new demand and provide for displaced demand from the removed crossing at the Park Road junction, it is proposed to introduce a new Toucan-type signal-controlled crossing between the Victoria Park and Anglesea buildings.

The new crossing is intended to be a feature which provides a gateway to the University, with a 6.0 metre wide crossing area in the centre of a larger table raised to footway level to provide an uninterrupted crossing area for pedestrians. The approach ramps to the new table will be of a shallow angle to minimise deflection and discomfort for vehicle drivers and passengers when traffic is flowing freely. The footways on either side of the road will be widened to increase capacity and will benefit from improved public realm measures including the use of distinctive and eye-catching materials, as will the crossing itself.

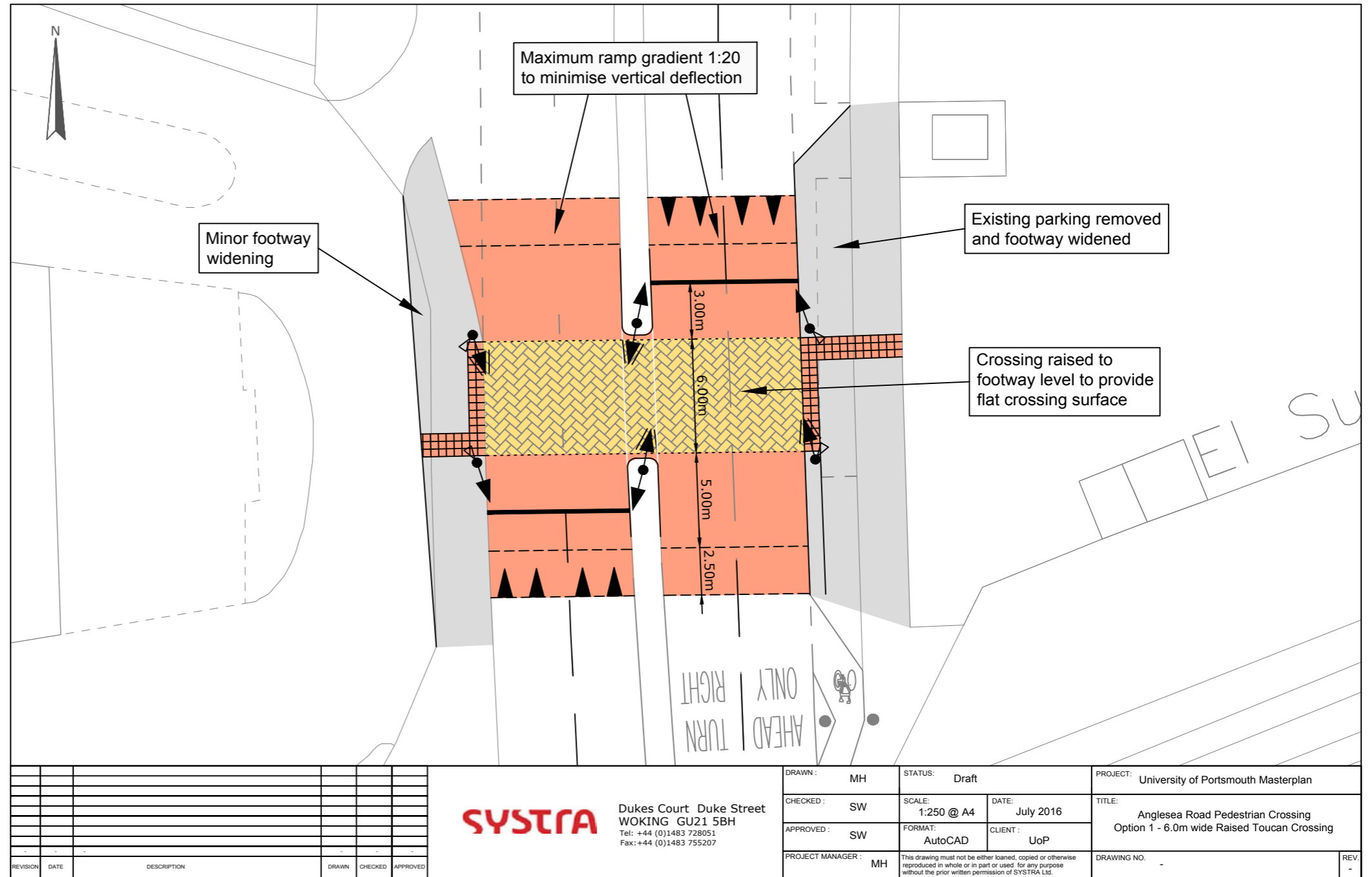

3.0 Masterplan Strategies

3.9 Highways Portland Street Public Realm

The area to the east of the current Portsmouth Business School between it and the ICG building is subject to a high level of pedestrian movements by students and University staff but is bisected by Portland Street, which connects St. James Street to the ICG car park and beyond to Park Road

Surveys have shown that a daily average of 165 vehicles per hour use Portland Street during the busiest hour for traffic, the AM peak period between 8am-9 am, and that an hourly average of 120 vehicles use this route between 7am-7pm.

The areas to either side of the carriageway are used for cycle parking and recreational activities between classes and the area is frequently busy with students, many of whom will need to cross Portland Street to access the various University facilities in the area.

The University therefore has an aspiration to improve the environment of the square between the Business School and the ICG building through a raft of public realm improvement measures and, potentially, the re-routing of traffic across the square, and two options for potential improvements have been drawn up.

In Option 1, traffic movements across the square would be removed by turning Portland Street into a cul-de-sac and re-opening Richmond Place, to the south of the Business School building to vehicular traffic. This would greatly reduce the potential of conflicts between pedestrians and vehicles and allow a more pedestrian and cycle friendly environment to be achieved using public realm improvement measures.

In Option 2, through traffic movements would be retained in Portland Place but the carriageway would be raised to footway level and be surfaced in similar materials to those that will be used in pedestrian areas to give an enhanced perception of pedestrian priority.



01

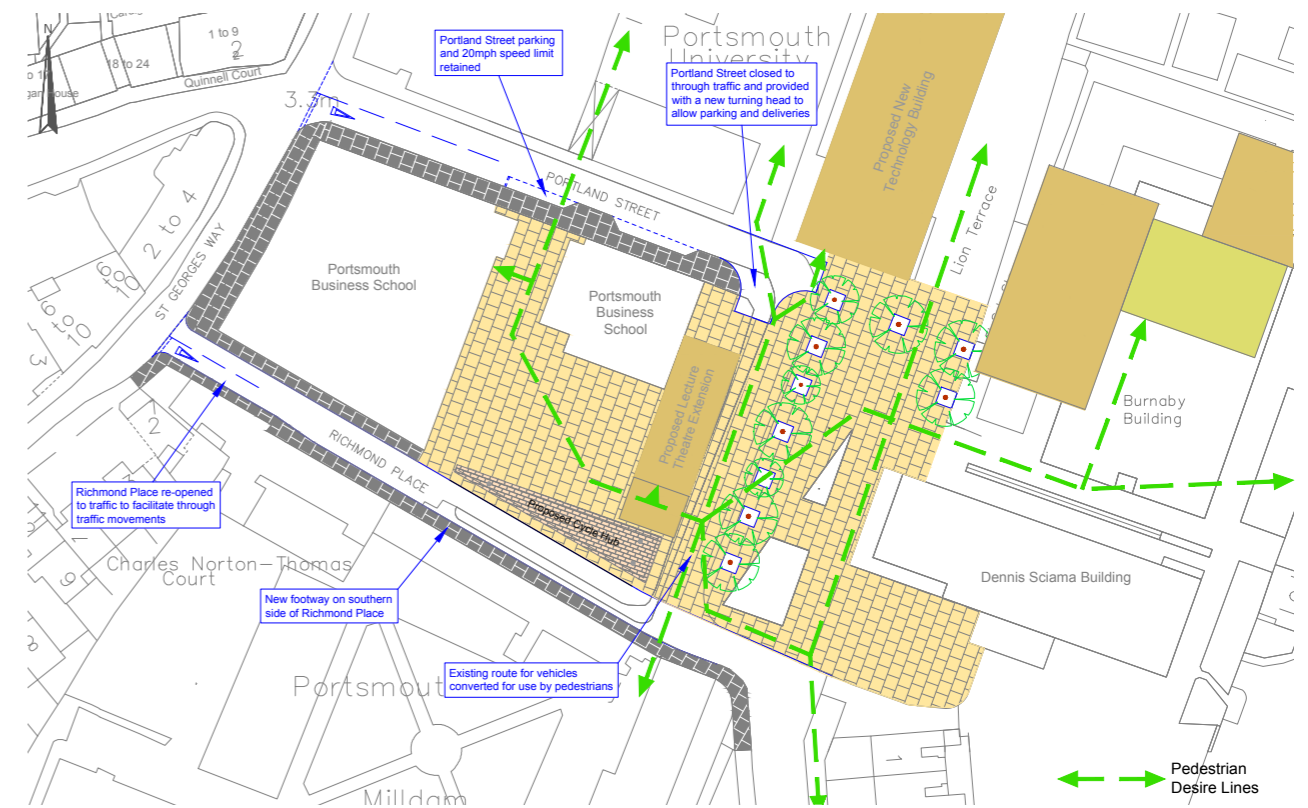

02

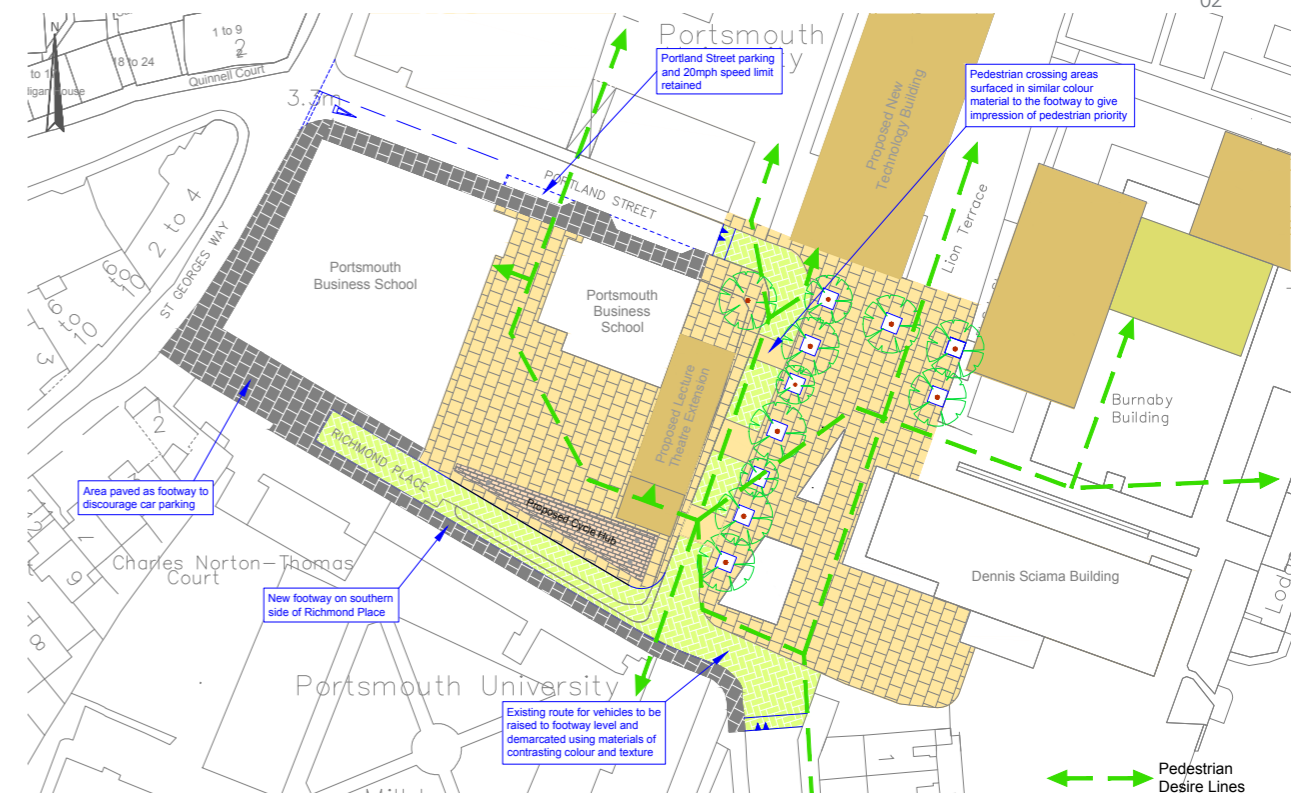

03

- 01 Existing Portland Street
- 02 Option 1
- 03 Option 2

3.0 Masterplan Strategies

3.9 Highways Hampshire Terrace Pedestrianisation

In its own Masterplan for the city, Portsmouth City Council identifies an aspiration to make changes to the layout of the A3 in the area of the University's St. Andrew's Court and International College buildings. The A3 currently operates as a gyratory system in this area, with traffic from the north travelling along King Richard I Road and Hampshire Terrace to reach destinations in the south and vehicles from the south using St. Michael's Road.

The council's proposal is to close Hampshire Terrace to traffic to create a new pedestrianised area of public realm, with traffic being routed through two new signalised junctions at Anglesea Road/King Richard I Road/St. Michael's Road to the north and St. Michael's Road/Cambridge Road to the south.

The University has commissioned transport consultants SYSTRA to examine the feasibility of this arrangement, and they have recently undertaken traffic surveys in order to understand the volumes of traffic that move through this area. Initial findings suggest that it would be possible to adopt such a layout, and SYSTRA will expand on this work by preparing conceptual layouts for the new junctions and testing these their capacity and potential for delays to traffic using proprietary junction modelling software.

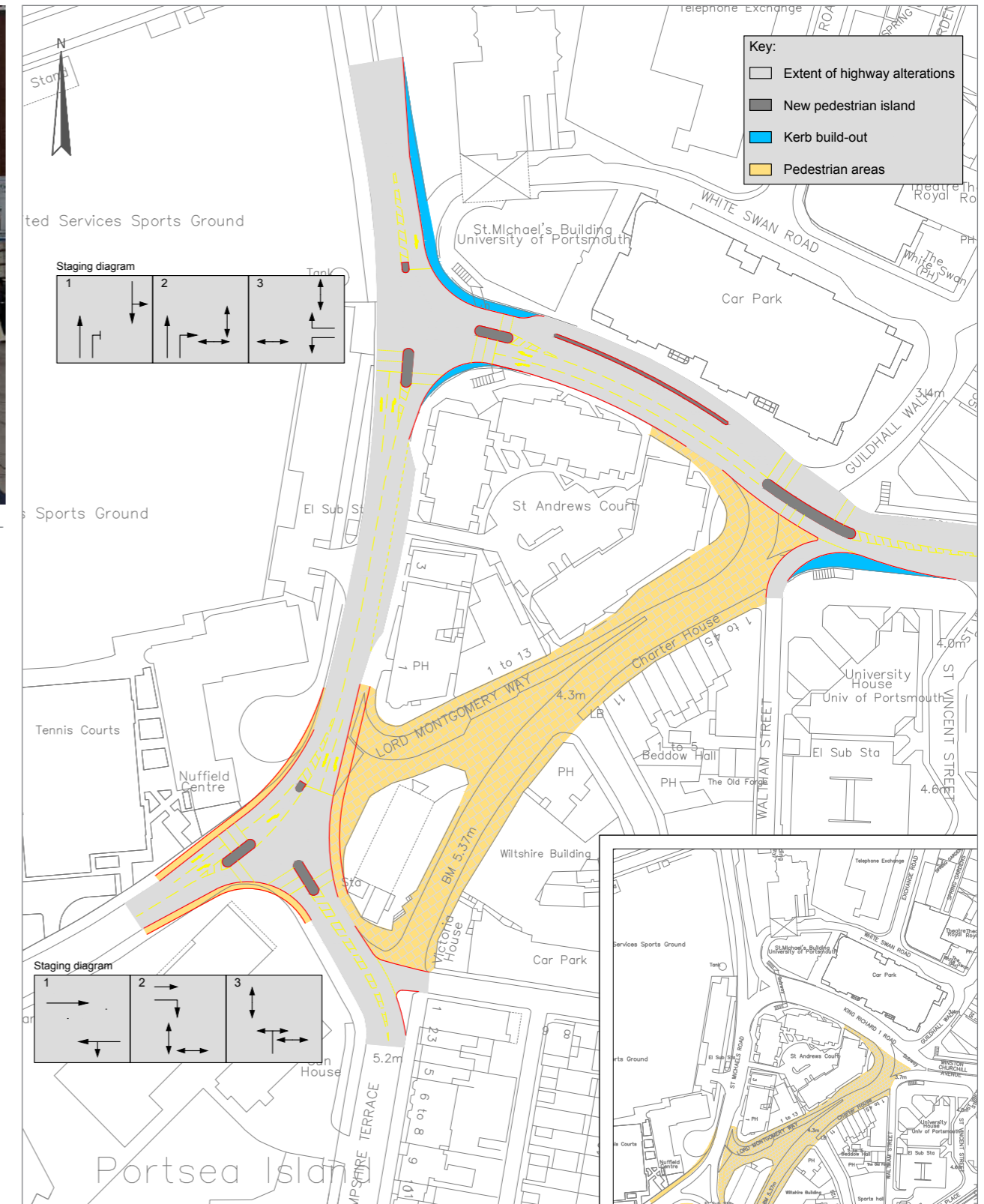

01 Hampshire Terrace existing
02 Proposed pedestrianisation

3.0 Masterplan Strategies

3.10 Car and Bicycle Parking

Cars

There are many surface level University car parks distributed across the campus totalling about 850 spaces. Each of these car parks represents valuable develop-able land for future growth. The University is seeking to reduce car use and encourage sustainable forms of transport through the Green Travel Plan which is currently being renewed, but acknowledge that in the short to medium term, staff parking will need to be retained at least at current levels.

Potential sites for multi-storey have been considered as shown on the plan opposite and following discussion with the University it has been agreed to pursue P1, P2 and P4, which between them would accommodate approx 730 cars, leaving 150 of the existing 850 total to be accommodated at other surface level car parks.

P1 and P2 are University owned land, P4 is a PCC owned surface level car park in front of an existing multi-storey. Further discussions are to be held with PCC to consider the options for shared use multi-storey.

Bikes

Secure bike stores are found in the following locations:

- Mercantile House
- Burnaby Terrace Car Park
- James Watson Hall

Additionally there are several locations of cycle hoops.

In order to further encourage cycling any new development should incorporate secure cycle storage within the vicinity of the building and staff showers within the building.

Safe cycle routes around the City will be the subject of further discussion with PCC Highways.

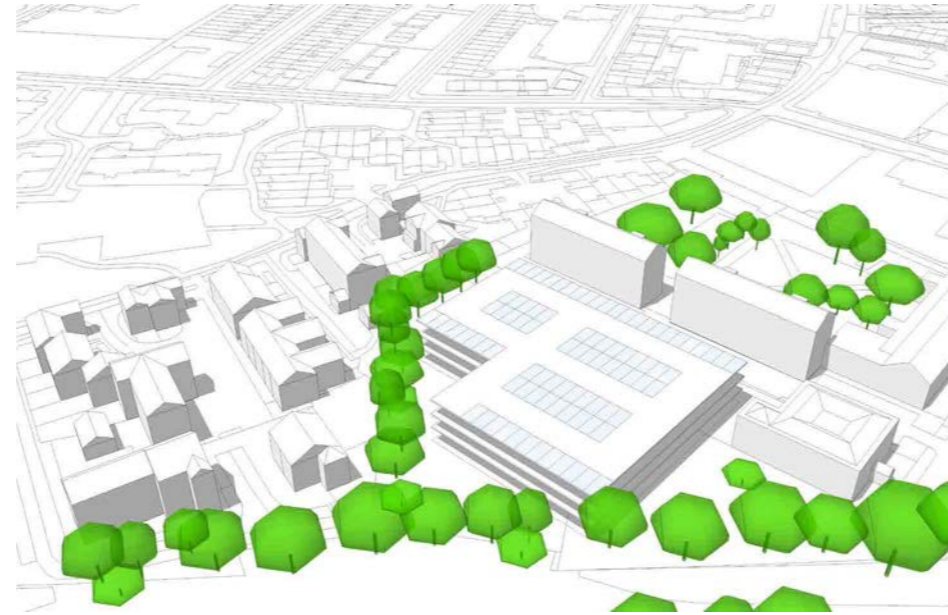

01

Urban design principles:

Development of a multi storey car park adjacent to a listed building and residential uses will need to be carefully considered. Potential issues are:

- Relationship to the listed building and its setting, height and massing as well as materials.
- Traffic impact.

The mass of the buildings will need to be broken down, with the upper storeys potentially stepping back from the listed buildings. Also some kind of screening will need to be considered.

We expect that the western boundary to the existing houses would also need to be screened with a landscape buffer to mitigate the impact.

As above, due to the conservation area and proximity of the listed building any design proposals will need to be carefully considered and developed in dialogue with the local planning authority to ensure any concerns are addressed as early as possible within the planning process.

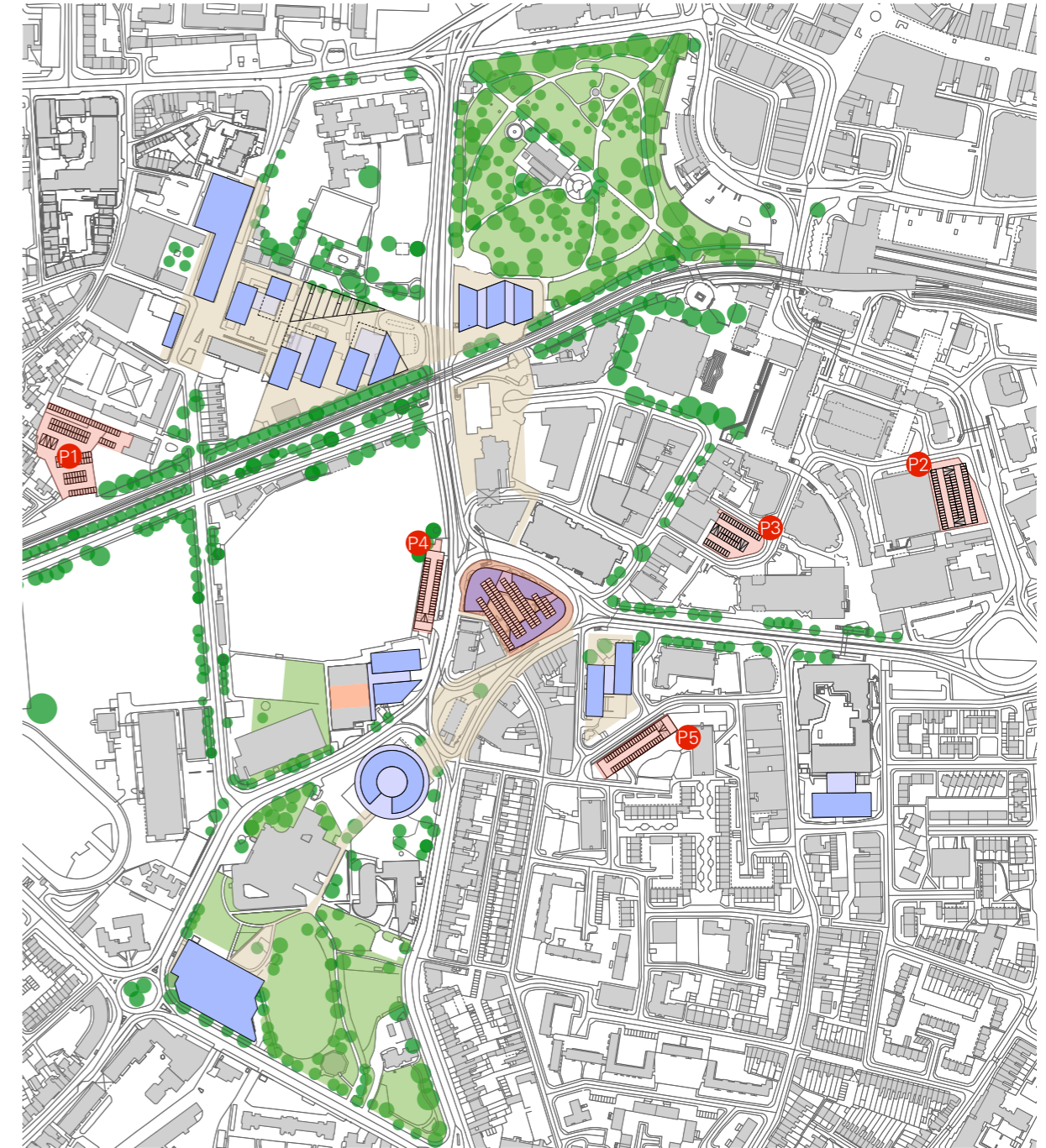

02

Key

- P1 Approx. 350 spaces
- P2 Approx. 300 spaces
- P3 Approx. 170 spaces
- P4 Approx. 80 spaces
- Sub total: 900 spaces
- P5 Approx. 90 spaces
- P6 Approx. 120 spaces

01 Proposed Milldam multi storey
02 Potential car park sites

4.0 Masterplan Projects



4.0 Masterplan Projects

Overview

Key to Projects

- 01 New Business and Humanities Building
20,000m² and Anglesea Crossing
- 02 New Sports Building
8,000m²
- 03 Richmond Lecture Theatre refurb and extension
1,000m²
- 04 New Technology Building
10,000 - 14,000m² (Buckingham and Liongate demolished 6,800m²)
- 05 King Henry, St Michael's Old and St Michael's New
refurbishment/remodel 18,800m²
- 06 Mercantile - ongoing refurbishment programme
- 07 New Student Hub
6000m² new build option
- 08 New Academic Building plus Spinnaker refurb
5400m² (Nuffield demolished 3880 m²)
- 09 Anglesea Redevelopment
20,000m² (Anglesea and Burnaby demolished 15,150m²)
- 10 Wiltshire Bldg/St Paul's site - future redevelopment potential
- 11 Eldon Extension
4500m²
- 12 New Academic Building
6000m² (University House demolished 3100m²)
- 13 St Andrew's Quarter Redevelopment
16,500m² (extg St Andrew's Quarter demolished 4700m²)
- 14 Hampshire Terrace pedestrianisation

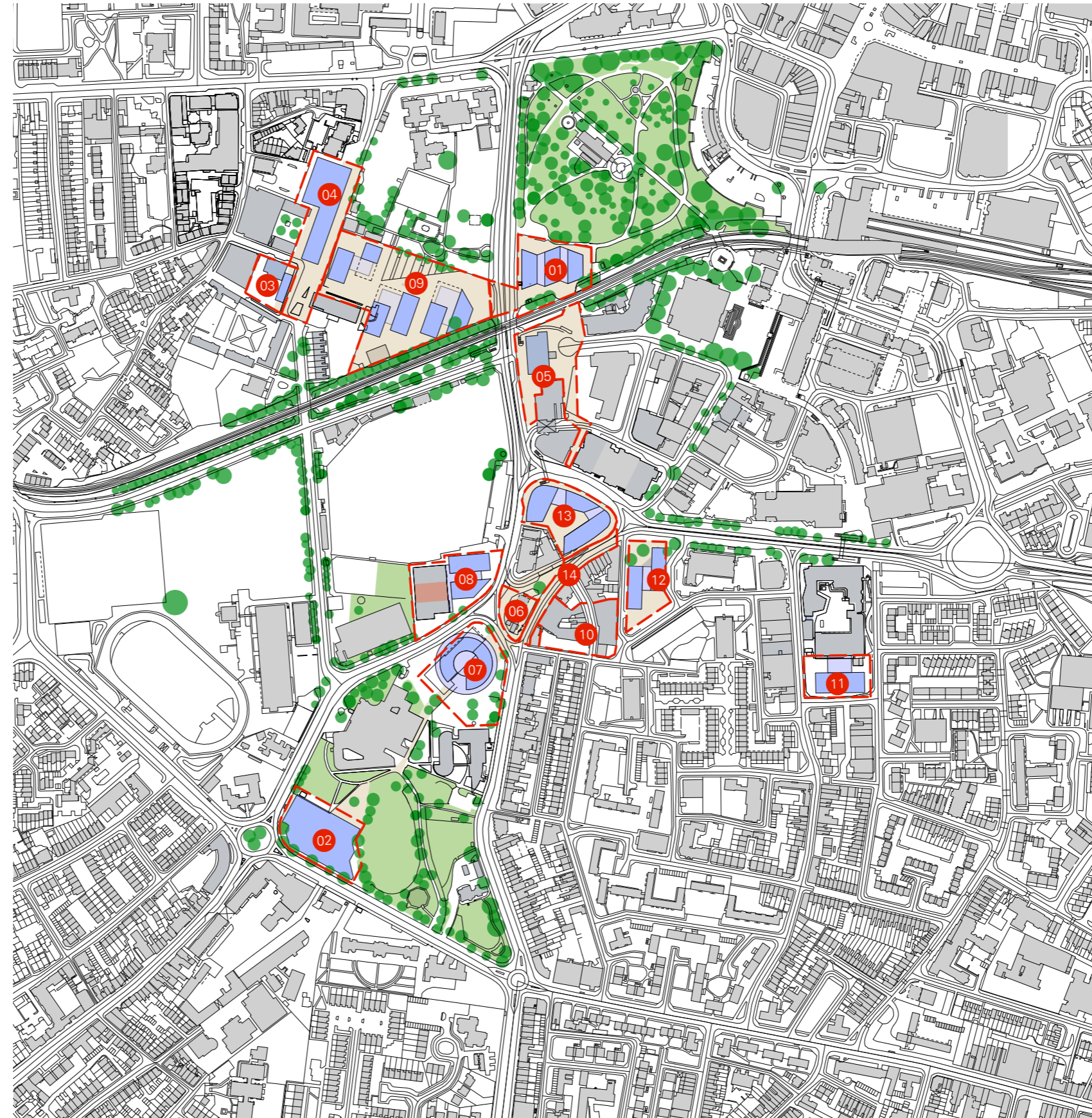

4.0 Masterplan Projects

4.1 Northern Quarter

The Northern Quarter presents a significant opportunity for major redevelopment, including the site of the existing Anglesea Building. The masterplan envisages this to be a new Science and Technology Quarter, with a clearly defined route connecting the new Business and Humanities Building on the Victoria Park site through to the Northern Quarter and western edge of the campus.

New academic buildings would open onto a generous new public space with new seating, lighting and tree planting. The proposed buildings would have fully glazed ground floors and atria allowing for views into the heart of the buildings. The new buildings will include ground floor uses such as social learning spaces, cafes and exhibition space which help to activate the public space.

The existing space between Dennis Sciana and Richmond Buildings is currently bisected by Portland Street. By introducing a shared surface, a new public space is created which forms the central hub of the Northern Quarter.

Urban design principles:

- Create a central focus of activity in form of a public space.
- Improve legibility and create public east/ west pedestrian routes through the northern quarter.
- Animate Lion Terrace with active ground floors.
- Improve the quality of the existing listed buildings and be sensitive to and where possible improve their setting as well as that of the listed wall.

KEY

- 1 New Business and Humanities Building
- 2 Anglesea Road crossing
- 3 Science and Technology Quarter
- 4 New public realm and pedestrian route
- 5 New Technology Building
- 6 New public realm in Liongate Terrace
- 7 Richmond Lecture Theatre extension
- 8 New square with shared surface
- 9 Richmond Building
- 10 Portland Building
- 11 HMS Nelson
- 12 Student route from Victoria site into Central Quarter



4.0 Masterplan Projects

4.1 Northern Quarter New Business and Humanities Building

The Victoria Park site has planning permission for a new faculty building and student residential tower of 33 storeys, totalling just under 27,000m².

The new building proposed for Business, Humanities and the Executive is between 16,000m² and 20,000m² and up to 16-20 storeys.

Draft Schedule of Accommodation

Business School 9270m²

comprises:
 Reprovision from Richmond 6,800m²
 Reprovision from Portland 1250m²
 Law School 600m²
 Allowance for student growth 520m²
 Exec Education Lounge 100m²

Humanities 3160m²

comprises:
 Reprovision from Ravelin House 640m²
 Reprovision from St George's Building 2000m²
 Re provision from Milldam 2800m²
 Re provision from Burnaby Terrace 800m²
 Allowance for student growth 520m²

Directorate 700m²

Reprovided from 3rd floor of Uni House

CPD facility 270m²

Dedicated seminar spaces
 Use of shared lecture theatres

Shared University spaces 2600m²

1 x 500 seat lecture theatre 750m²
 1 x 300 seat lecture theatre 450m²
 1 x 150 seat lecture theatre 250m²
 Display/exhibition/events space 1150m²

TOTAL GIA 16,000m²
TOTAL GIA (inc Milldam and Burnaby Terrace) *19,600m²

refurb	extg student numbers taken from information issued by UoP 29.07.15
demolition or vacate	2020/21 student growth target numbers taken from University Strategy 2020/21
new build	

PORTSMOUTH BUSINESS SCHOOL		Present	2020/21
Building Name	Departments	GIA	GIA
Richmond Building		6800	0
Portland Building		1250	0
Anglesea Building	Law School	600	0

Proposed masterplan development			
Victoria Park site	space from Richmond, Portland and Anglesea	8650	
	allowance for student growth	520	
	Executive Education Lounge	100	

TOTAL		8650	9270
--------------	--	-------------	-------------

Student Growth Target (full time campus based UG/PGT/PGR - Home/EU/International)			
2014/15	UG 3406, PGT 1418, PGR 124		
2020/21	plus 120 UG & PGT, 25 PGR		
from NOCAG 1987 Space Norms			
UG & PGT	3.3m ² per student	120 x 3.3m ²	396m ²
PGR	5m ² per student	25 x 5m ²	125m ²
Total			521m²

FACULTY OF HUMANITIES AND SOCIAL SCIENCES		Present	2020/21
Building Name	Departments	GIA	GIA
Park Building	School of Languages and Area Studies	8528	8528
Park Annex		335	335
Milldam Building (LB,LC,LD,LF)	School of Social, Historical and Literary Studies	2800	0
Ravelin House	Institute of Criminal Justice Studies	640	0
St George's Building	School of Education and Continuing Studies Institute of Criminal Justice Studies	2000	0
Burnaby Terrace	Academic Offices	800	0

Proposed masterplan development			
Victoria Park site	allowance for student growth	6240	520

TOTAL		15103	15623
--------------	--	--------------	--------------

Student Growth Target (full time campus based UG Home/EU/International)			
2014/15	3753 students		
2020/21	plus 200 students (50 Home/EU, 150 International)		
from NOCAG 1987 Space Norms	- 2.6m ² per student = 520m ² (this figure used to estimate additional GIA)		

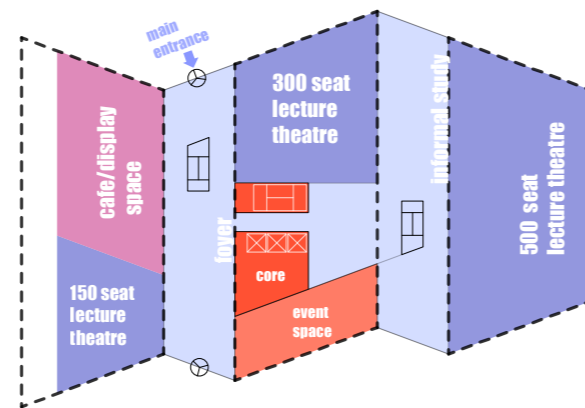

01

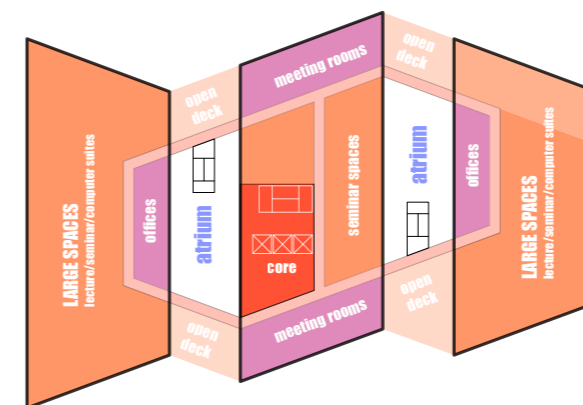

02

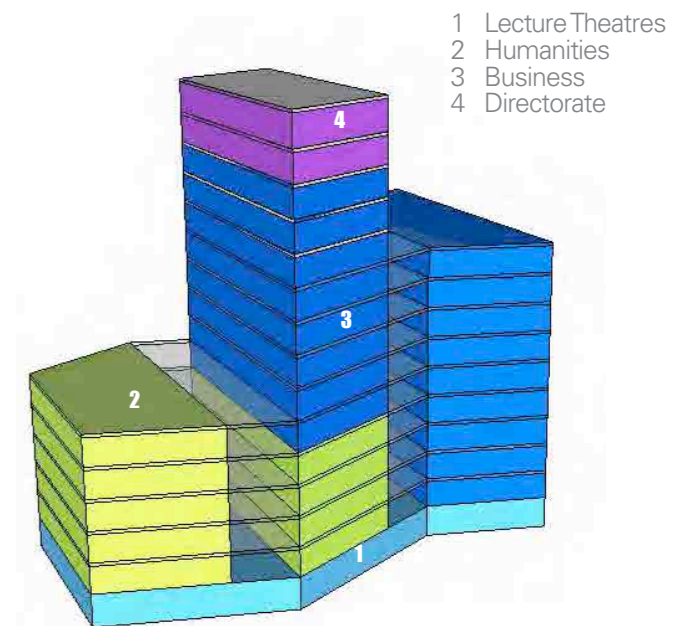

03

- 01 Ground Floor
- 02 Upper Levels
- 03 Massing Diagram

4.0 Masterplan Projects

4.1 Northern Quarter New Business and Humanities Building

The Victoria Park site is in a Conservation Area and adjacent to a Listed park. The planning consent is however for a landmark building on this site, which would mark the entrance to the University Quarter.

The masterplan proposal is for a building divided into three towers with atria between, with height of towers modulated to respect the different context to east and west.

The building continues the student route through the site, and it is envisaged that the base of the tower on Anglesea Road would be a public space (cafe/events/gallery) to encourage greater interaction between the University and the public, and to celebrate the learning and research activities within the University.

Shared Lecture and foyer spaces will be located at the lower levels to provide a potential conference venue out of term time. Upper levels would be divided between a range of learning and study spaces for Business and Humanities, with the Executive Suite located at the top of the building.

The site has already been piled in preparation for the previously consented scheme and it is assumed that this would prevent the inclusion of basements, and that parking would be provided elsewhere on campus. Deliveries and servicing would be via Anglesea Road.

Urban design principles:

- Create a high quality landmark building on this prominent site that clearly defines the gateway to the University Quarter.
- In line with the recent planning approval this is an opportunity for a taller building. Any new building will need to balance the existing scale of Anglesea Road and the sensitive location at the edge of the park.
- Improve and provide public pedestrian connections to the park and towards the west across Anglesea Road.
- Consider and retain where possible existing views to the listed Park building.

KEY

- 1 New Building
- 2 Public uses on Anglesea Road frontage
- 3 Connection under railway to Central Quarter
- 4 New Anglesea Road crossing
- 5 New public realm/entrance from Victoria Park
- 6 Service/Deliveries Yard

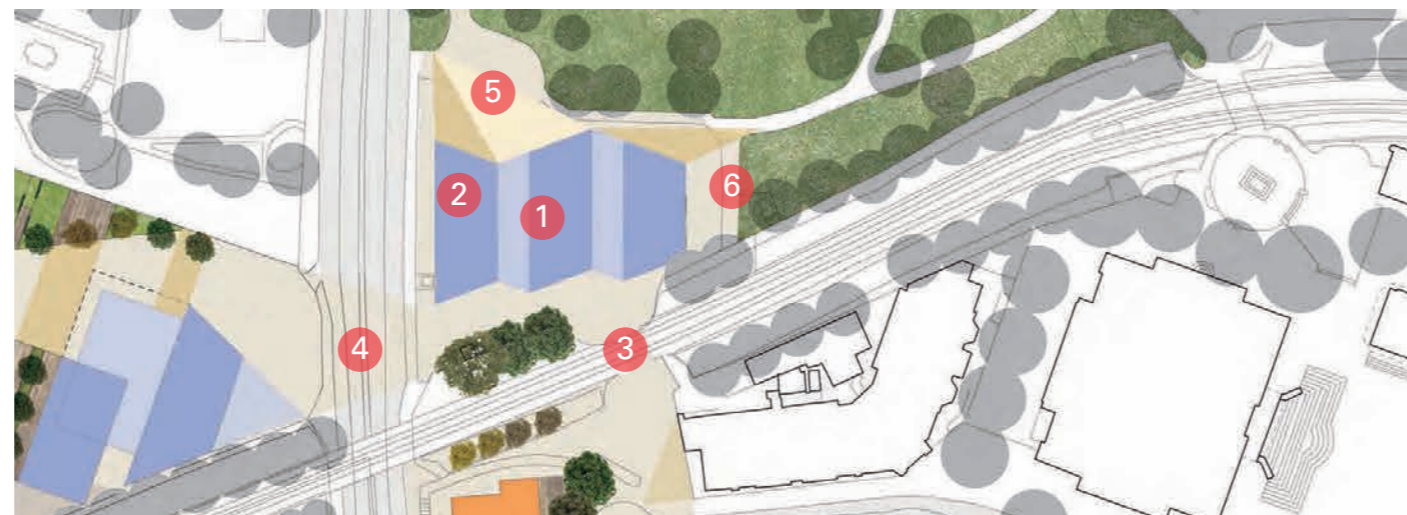

Business School
Robert Gordon University, Aberdeen



Manchester University Business School



Business School, Exeter University

4.0 Masterplan Projects

4.1 Northern Quarter New Technology Building and Richmond Lecture Theatre extension

The redevelopment of the New Technology Building to replace Buckingham and Liongate provides the opportunity to create a building that celebrates the activities within by placing workshops on the ground floor, visible from and opening onto the pedestrianised section of Lion Terrace.

Relocating Business from the Northern Quarter into the New Business and Humanities Building facilitates the decant of both Liongate and Buckingham and the redevelopment of the whole site, increasing the GIA by approx 3200m².

The new Technology Building is approx *10,000m² and the footprint of the building would be similar in width to the existing Buckingham Building due to site constraints, but by locating the main circulation spine to one side, overlooking the Portland courtyard, a range of sizes of internal spaces can be accommodated. An active frontage is created to the courtyard with the potential for social and collaborative learning spaces within the main circulation spine.

***POTENTIALLY INCREASED TO 14,000m² TO MEET THE SPATIAL REQUIREMENTS FOR THE FACULTY OF TECHNOLOGY WITHOUT THE NEED TO INCLUDE DEVELOPMENT ON THE ANGLESEA SITE.**

refurb
demolition or vacate
new build

FACULTY OF TECHNOLOGY		Present	2020/21
Building Name	Departments	GIA	GIA
Buckingham Building	School of Computing	2050	0
Burnaby Building	School of Earth and Environmental Sciences	1000	0
King Henry Building	Department of Psychology	3150	3150
Liongate	Department of Mathematics	2700	0
Portland Building	School of CE and Surveying	6700	6700
Dennis Sciama	Institute of Cosmology and Gravitation	1700	1700
Anglesea Building	School of Engineering	5400	0
Anglesea Wings and Lodge	School of Engineering	3650	0

Proposed masterplan development		
Richmond Building	reallocated from PBS to Technology	6800
Liongate/Buck site	New Technology Bldg	10000
Anglesea site	New Academic Bldg	3880
		32230
TOTAL		26350
		32230

Student Growth Target (full time campus based UG Home/EU/International)	
2014/15	2925 students
2020/21	plus 600 students (400 Home/EU, 200 International)
this equates to a 20% increase in FT UG numbers	
20% increase in GIA equates to an additional 4850m ²	
from NOCAG 1987 Space Norms - 9.8m ² per student = 5880m ² (this figure used to estimate additional GIA)	

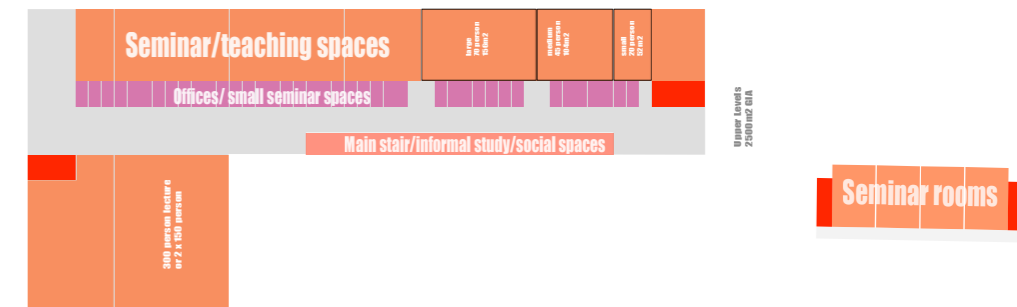

01 Ground Floor
02 Upper Levels

4.0 Masterplan Projects

4.1 Northern Quarter New Technology Building and Richmond Lecture Theatre extension

Vehicular access would be from Portland Street car park and Liongate Terrace would become an activated learning space with the potential for activities from ground floor workshops to spill into the external space.

The Richmond Lecture Theatre extension would provide 1000m² of social, meeting and seminar spaces, which would operate in conjunction with the Lecture Theatre to provide a potential venue for conferences and special events. The building would also provide the potential for the didactic teaching within the lecture theatre to be combined with collaborative, discussion based learning within the new extension, helping to further promote and facilitate a greater variety of learning scenarios.

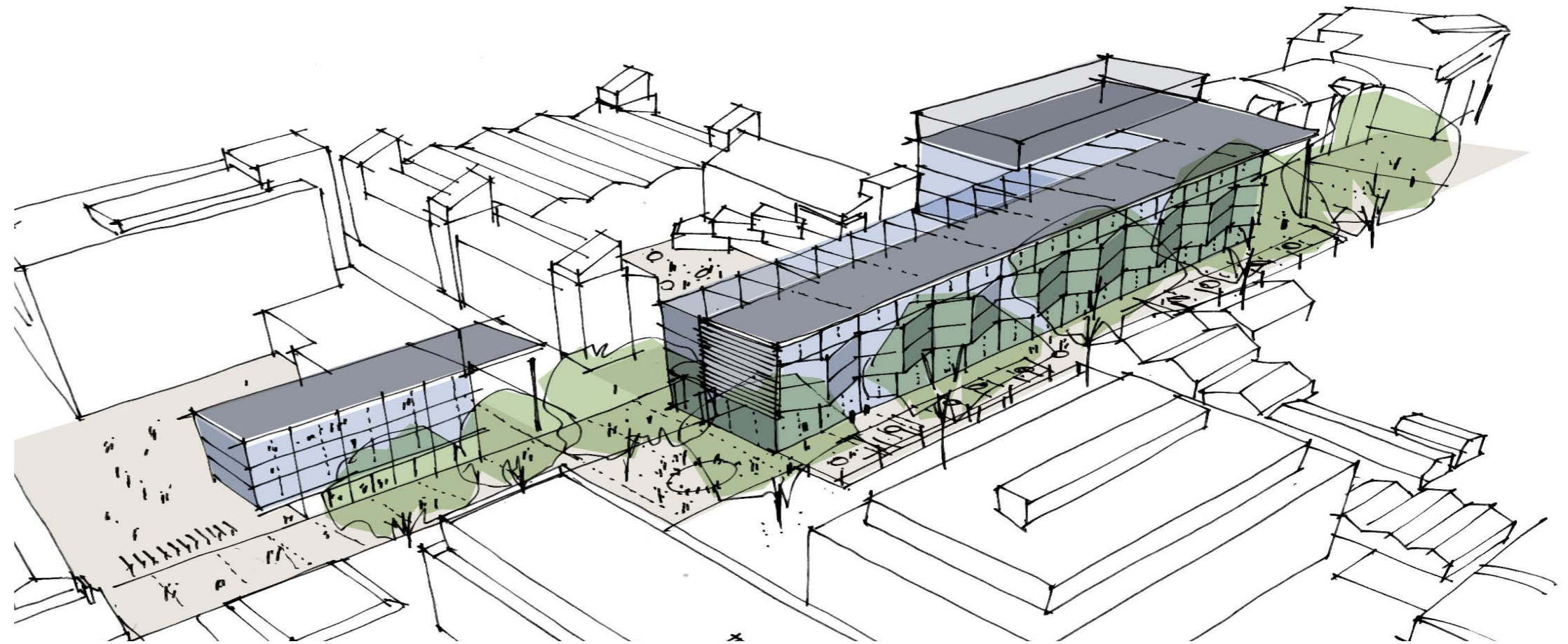

Urban design principles:

- Create an active frontage onto Lion Terrace.
- Enclose the street with consistent frontage and building height.
- Enhance and improve the central space, making it more attractive and creating a focal point for this quarter. Allow for activities to spill out of the surrounding buildings.



02



03



04

- 01 Sketch aerial view
- 02 New Technology Building opens onto Lion Terrace
- 03 Lancaster Uni Technology Bldg
- 04 Lancaster Uni Technology Bldg

4.0 Masterplan Projects

4.1 Northern Quarter Science and Technology Quarter

The Anglesea site represents a significant opportunity for redevelopment of the Northern Quarter, providing an increase in area across the site of approx 5000m², accommodated within three atrium buildings potentially providing new state of the art facilities, primarily for the Faculty of Science. An initial assessment of spatial requirements to accommodate targeted student growth in both Science and Technology indicates that the 20,000m² total GIA across the site would be split as follows:

Science 8890m²
Technology 3880m²
Other functions 7130m²

The University have introduced Nursing to the curriculum and the first cohort of 150 students are to be accommodated within St Andrew's Court. The development of the Science and Technology Quarter provides the opportunity for a new permanent facility to be provided as part of the Estates Masterplan.

Further long term ambitions that could be met by developing the Northern Quarter are for example a growth in Chemistry courses requiring highly serviced lab space which would most efficiently be provided in a new purpose built facility.

refurb
demolition or vacate
new build

FACULTY OF TECHNOLOGY		Present	2020/21
Building Name	Departments	GIA	GIA
Buckingham Building	School of Computing	2050	0
Burnaby Building	School of Earth and Environmental Sciences	1000	0
King Henry Building	Department of Psychology	3150	3150
Liongate	Department of Mathematics	2700	0
Portland Building	School of CE and Surveying	6700	6700
Dennis Sciana	Institute of Cosmology and Gravitation	1700	1700
Anglesea Building	School of Engineering	5400	0
Anglesea Wings and Lodge	School of Engineering	3650	0

Proposed masterplan development		
Richmond Building	reallocated from PBS to Technology	6800
Liongate/Buck site	New Technology Bldg	10000
Anglesea site	New Academic Bldg	3880
		32230
TOTAL		26350 32230

Student Growth Target (full time campus based UG Home/EU/International)	
2014/15	2925 students
2020/21	plus 600 students (400 Home/EU, 200 International)
this equates to a 20% increase in FT UG numbers	
20% increase in GIA equates to an additional 4850m ²	
from NOCAG 1987 Space Norms - 9.8m ² per student = 5880m ² (this figure used to estimate additional GIA)	

FACULTY OF SCIENCE		Present	2020/21
Building Name	Departments	GIA	GIA
Buckingham Building	Department of Geography	2050	0
Burnaby Building (plus Greenhouses)	School of Earth and Environmental Sciences	4600	0
King Henry Building	School of Biological Sciences	3150	3150
St Michael's Building New	School of Pharmacy and Biomedical Sciences	6700	6700
St Michael's Building Old	School of Pharmacy and Biomedical Sciences	5800	5800
James Watson West	School of Health Sciences and Social Work	1300	0
Spinnaker Building	School of Sport and Exercise Science	1800	1800
Spinnaker Sports Centre	School of Sport and Exercise Science	1600	1600
Dental Academy	Dental Academy	1850	1850
William Beatty Bldg	Dental Academy	1100	1100

Proposed masterplan development		
Nuffield site	New Academic Bldg	5400
Anglesea site	New Academic Bldg	8990
		36390
TOTAL		29950 36390

Student Growth Target (full time campus based UG Home/EU/International)	
2014/15	4056 students
2020/21	plus 700 students (550 Home/EU, 150 International)
this equates to a 17% increase in FT UG numbers	
17% increase in GIA equates to an additional 5450m ²	
from NOCAG 1987 Space Norms - 9.2m ² per student = 6440m ² (this figure used to estimate additional GIA)	

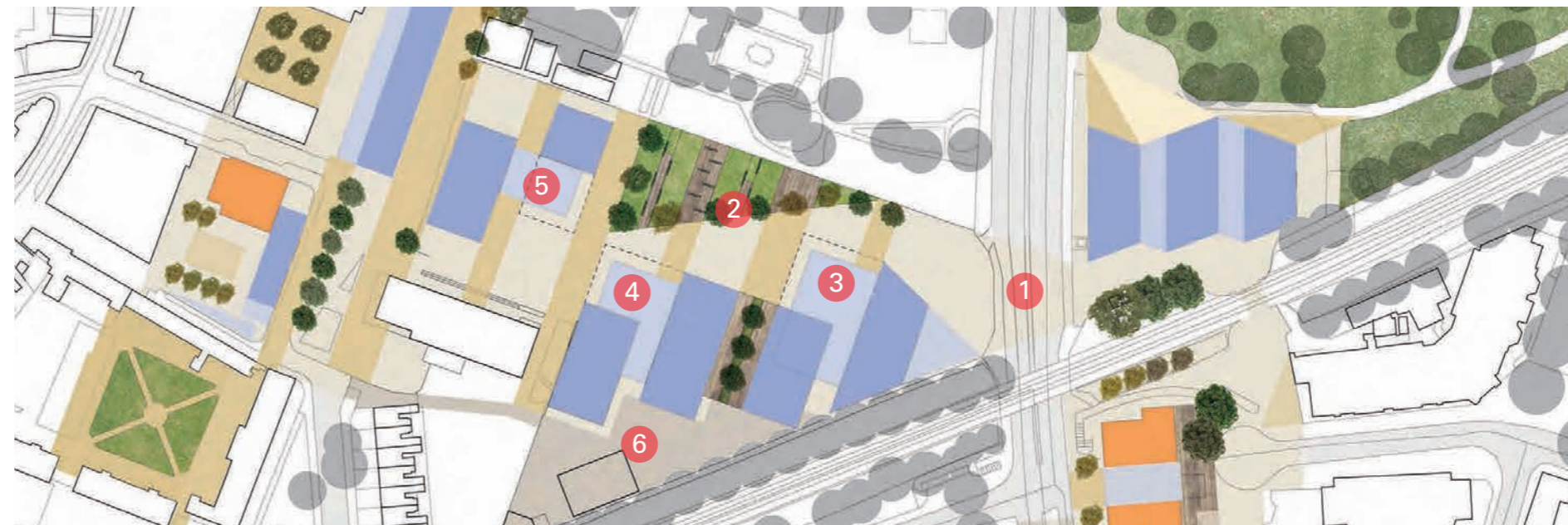

KEY

- 1 New Anglesea Crossing
- 2 New public space and pedestrian route
- 3 Bldg 1 8000m²
- 4 Bldg 2 7000m²
- 5 Bldg 3 5000m²
- 6 Service/Deliveries

4.0 Masterplan Projects

4.1 Northern Quarter Science and Technology Quarter

The new buildings are arranged to face onto a new public space, providing places for informal study, socialising and relaxing. A new pedestrian route with clear lines of site between the Richmond Building and the New Business and Humanities Building will serve to dramatically improve the connectivity through the Northern Quarter and connections to the rest of the University campus via the Victoria Park site.

Vehicular access to the site would be via Burnaby Terrace a delivery/services area between the building and the railway line, leaving the new public space to be vehicular free.

The site is within the Victoria Park Conservation Area and adjoins the grounds of the Grade II Listed HMS Nelson. The scale of buildings rise towards Anglesea Road and are consistent with the height of Dennis Sciana Bldg along the eastern edge.

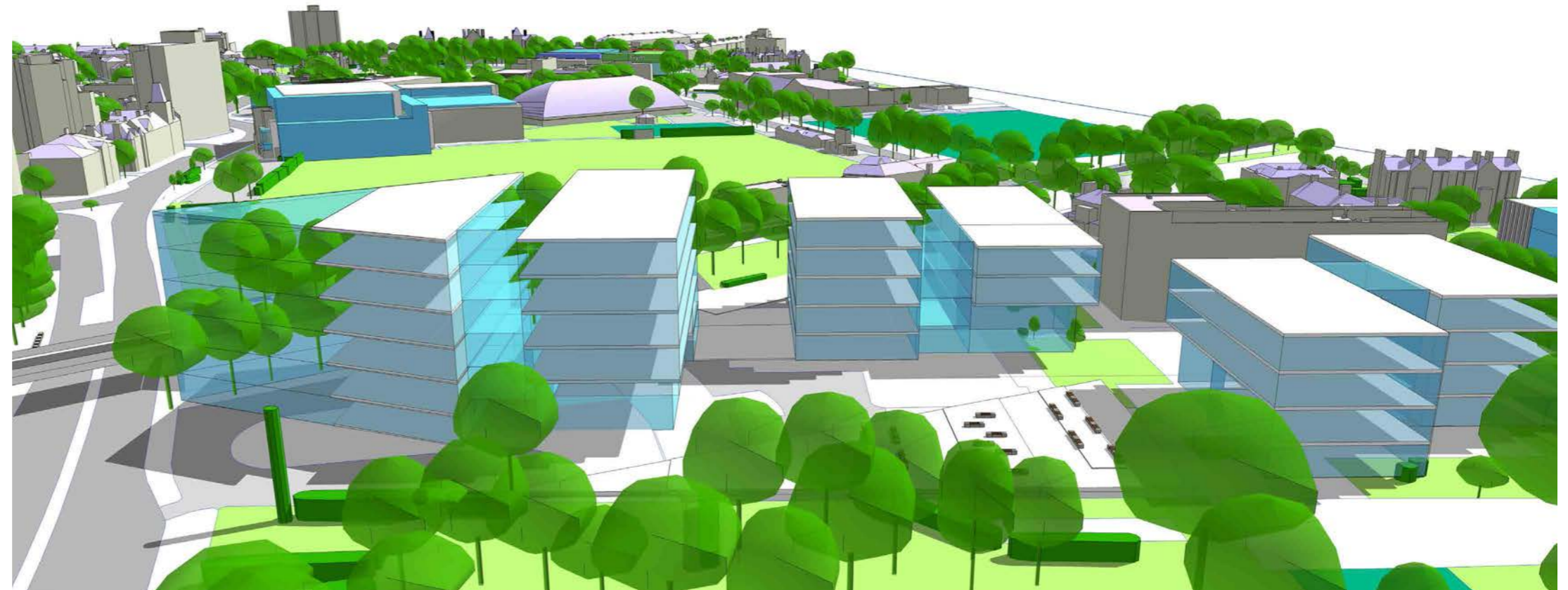

Urban design principles:

- Create a gateway to the University, with building heights subservient to the new Business and Humanities building.
- Improve the legibility through this area and create attractive public pedestrian routes.
- Respect and improve the setting of the listed wall.
- Create a clear definition of spaces.
- Reduce heights from Anglesea Road towards the listed buildings.

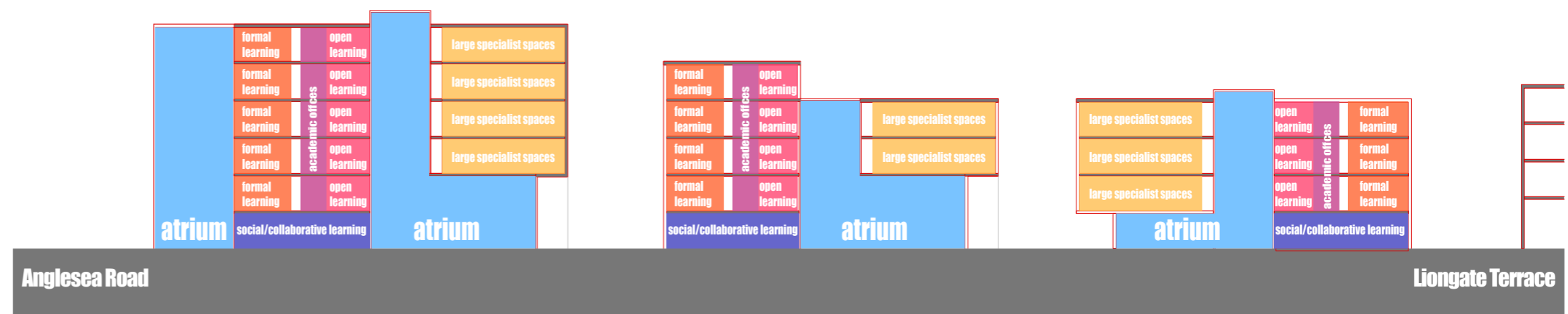

Sketch section through Anglesea site

4.0 Masterplan Projects

4.2 Central Quarter

The Central Quarter is the part of the campus that is most integrated with the city, being adjacent to the civic centre of Portsmouth, and comprising several University buildings distributed amongst the fabric of this part of the city.

All University buildings within the Central Quarter face onto major roads which create a conflict between vehicular and pedestrian movement. St Andrew's Court in particular is effectively an island, surrounded by busy roads, reliant on an underpass and signalled crossing for safe pedestrian access. The proposed pedestrianisation of Hampshire Terrace, which is included within the City Centre masterplan, would significantly improve the connectivity between St Andrew's Court and University buildings to the east (Eldon, University House).

It is envisaged that any building projects would include improvements to the public realm, seeking opportunities for creating more usable incidental public spaces, such as the wide pavement in front of St Michael's Old. New paving, street furniture, green walls and lighting would all contribute to making a more pleasant public realm environment.

Urban design principles:

- Create a university presence along the street and strengthen the identity of the university within the city.
- Improve pedestrian routes, north-south as well as across to the west to Anglesea. Ensure that the existing subway is an attractive environment, safe and well lit.
- Create new landmark buildings at the end of Winston Churchill Avenue as well as at Nuffield House.
- Strengthen the northern gateway to the City Centre Campus and the Central Quarter with new development at Anglesea and the Victoria Park site.
- Improve the public realm, pedestrian crossing points and reduce the traffic impact where possible.

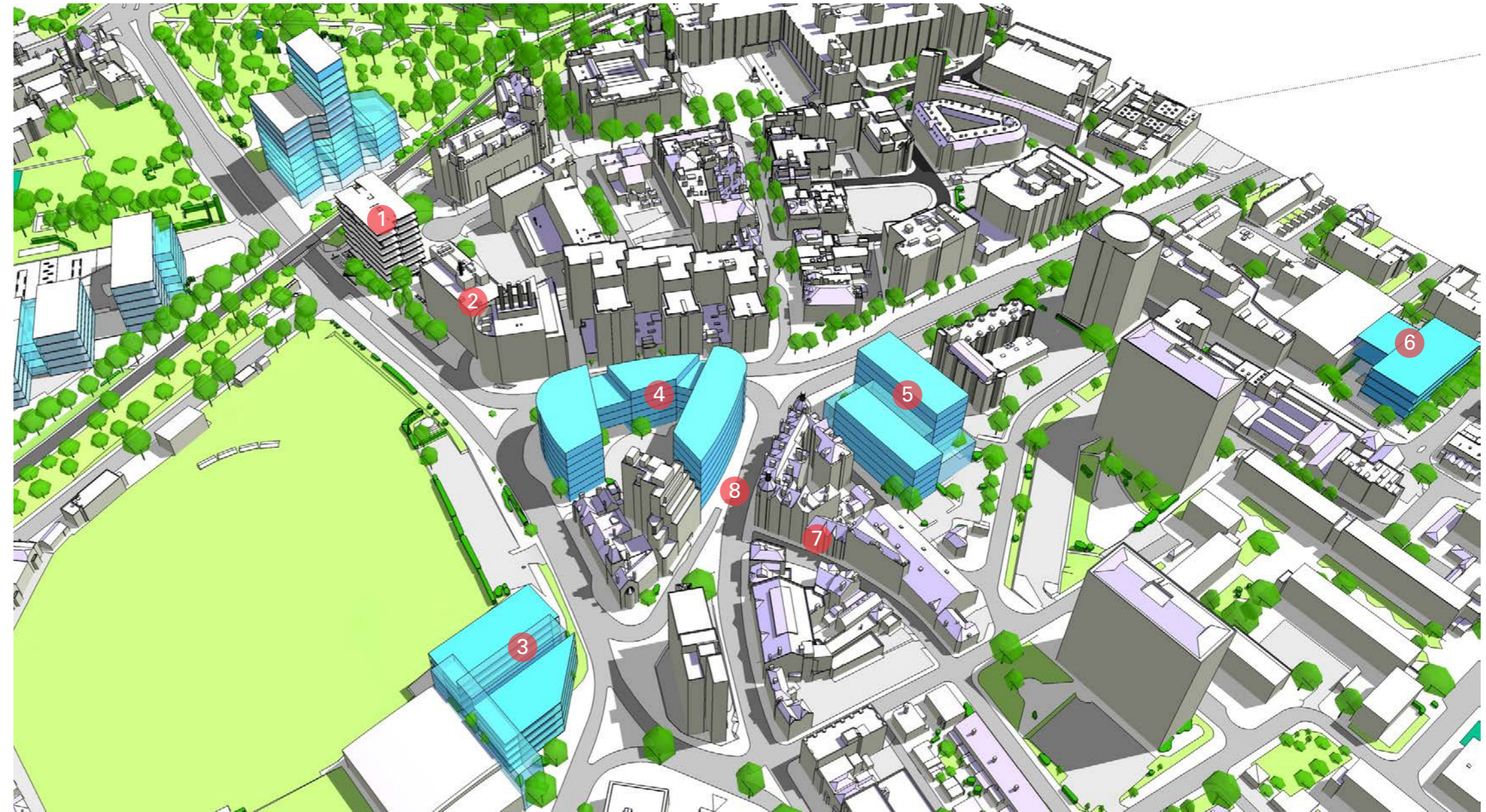

KEY

- 1 King Henry Building
- 2 St Michael's Buildings
- 3 Nuffield site
- 4 St Andrew's Court
- 5 University House site
- 6 CCI extension
- 7 Wiltshire/St Pauls site
- 8 Hampshire Terrace pedestrianisation

4.0 Masterplan Projects

4.2 Central Quarter King Henry and St Michael's Buildings

King Henry and St Michael's Buildings all contain science labs, and the University has concluded that in the medium term at least these buildings would be retained, although with a rolling programme of refurbishment.

King Henry Building truncates the historic link between the civic centre of Portsmouth and the harbour. The masterplan proposal for this building is to remodel the ground and first floor to create a generous, glazed foyer space with clear views through from Anglesea Road towards Park Building, and from Park Road (on east side of King Henry Bldg) through towards Gun Wharf. This would serve to re-establish this historic connection between city and harbour, provide the University with another threshold space, and provide a further opportunity for a shared social learning space at the base of an existing building.

The existing pedestrian route on the east side of St Michael's Old is severely constrained by the Telecom Building car park walls. It is envisaged that negotiations would be entered into with British Telecom to seek potential for reduction in car park size to enable a wider, safer route with improved site lines.

Public realm improvements along Anglesea Road include new seating outside the King Henry Building, and a pocket park with green walls in the recess between King Henry and St Michael's Old. These would need to be co-ordinated with an existing cycle route in this location.

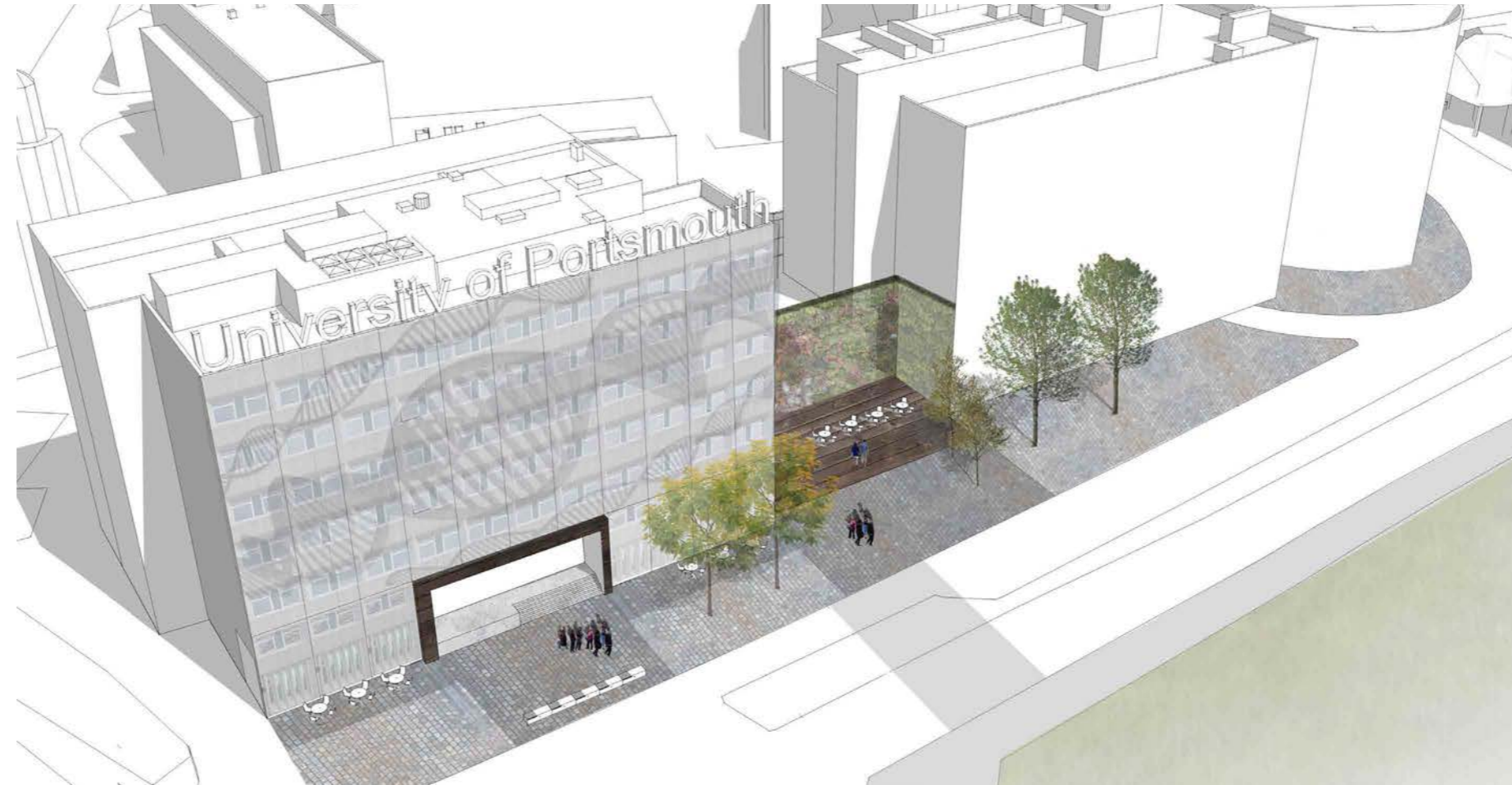

KEY

- 1 New foyer space at base of King Henry
- 2 Public realm improvements on Anglesea Road
- 3 Reconfigured BT car park
- 4 New terrace
- 5 Existing crossing

4.0 Masterplan Projects

4.2 Central Quarter Nuffield site

The existing Nuffield Centre is earmarked for demolition subject to the re-provision of student services within the new Student Hub. The site is adjacent to the Spinnaker Sports Centre and Sport Science, which has a requirement for additional space. It is therefore envisaged that a new academic building on this site would potentially include new expansion space for Sports Science and related functions, such as physiotherapy suites, related to the University's Health and Well Being agenda.

The site is located at a bend on the busy St Michael's Road and a generous forecourt aligned with the existing crossing should be provided at the entrance to allow students to gather safely.

The site would support an academic building of approx 5400m² at four storeys, although there may be potential to increase the height given its prominent location.

The site is constrained and would only support minimal on site parking. It is envisaged that the adjacent car park on Anglesea Road would be utilised for nearby parking.

Urban design principles:

- Improve the definition of the corner with a landmark building that relates to existing views along Hampshire Terrace.
- Define the edge to St Michael's Road with active frontages.

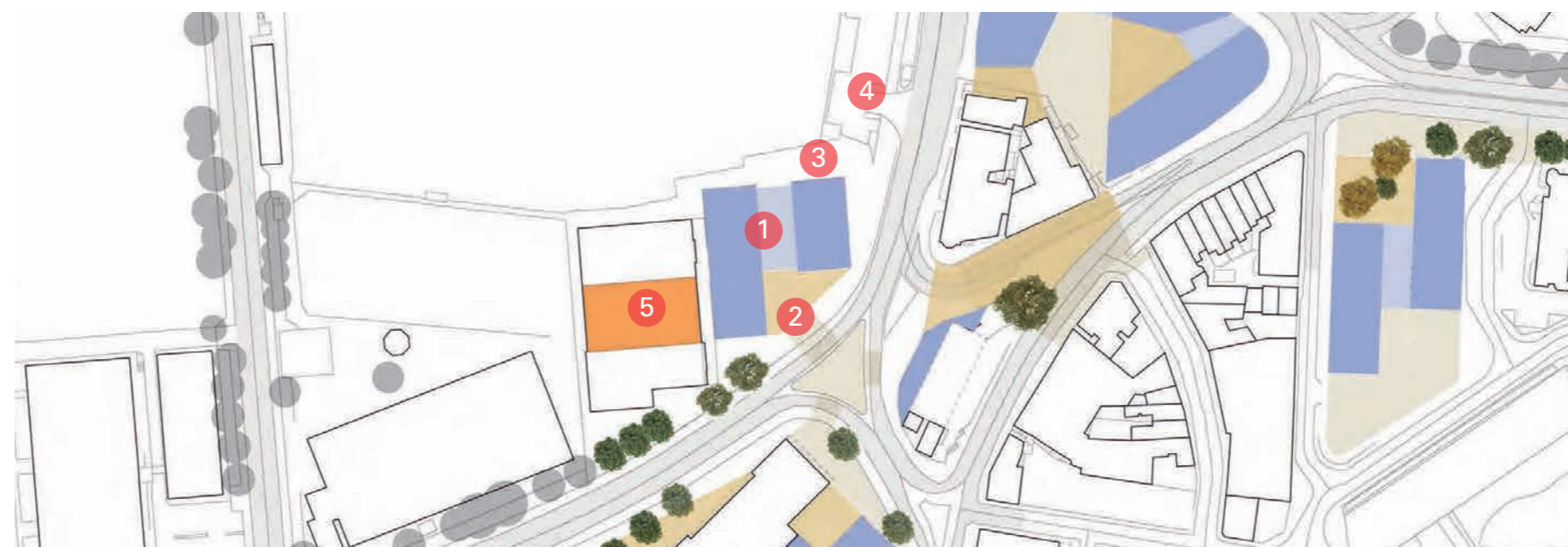
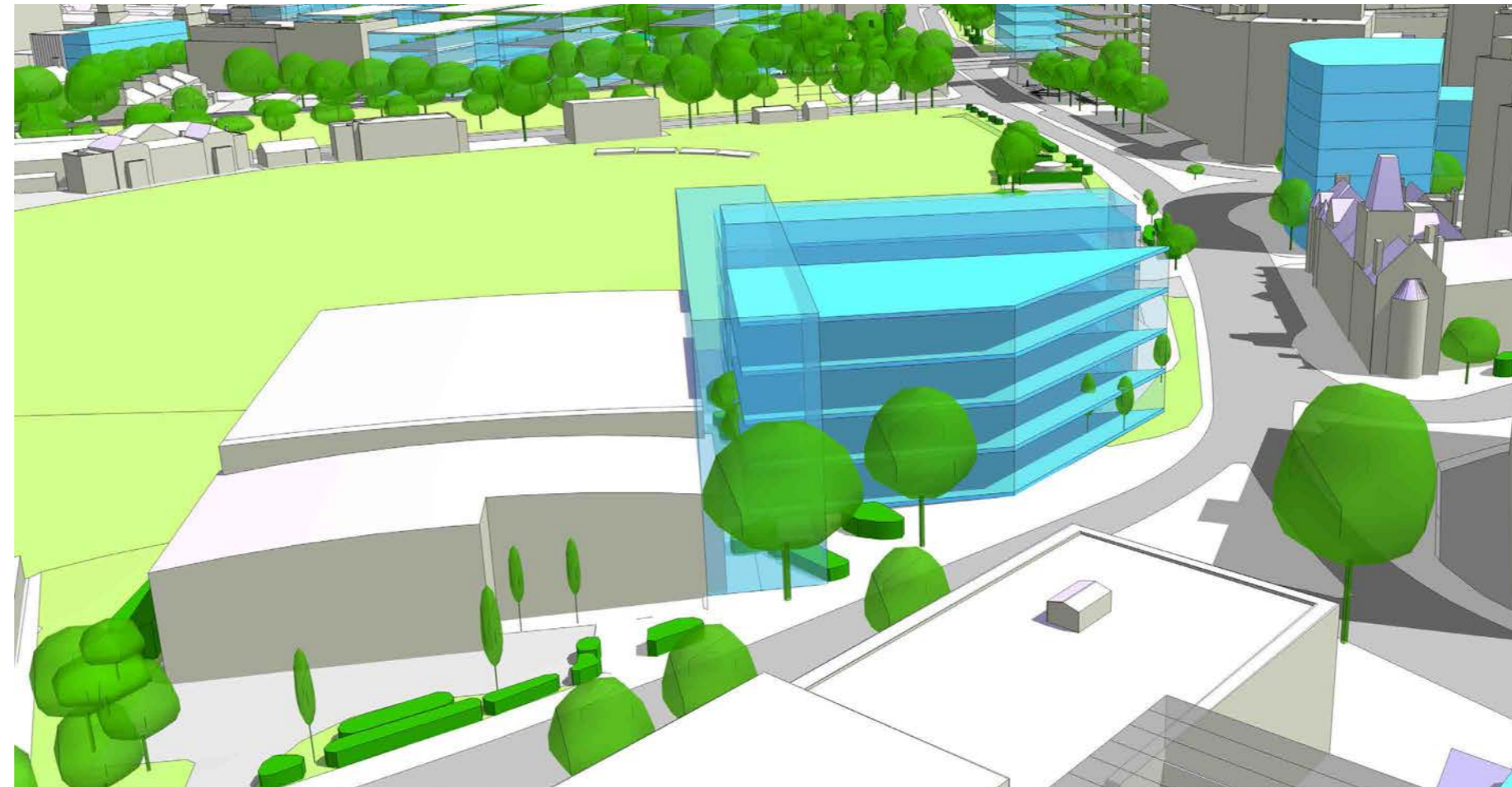

KEY

- 1 New academic building
- 2 Forecourt and main entrance
- 3 Service access
- 4 Adjacent parking
- 5 Refurbished Spinnaker Sports and Sports Science

4.0 Masterplan Projects

4.2 Central Quarter St Andrew's Court

St Andrew's Court currently houses a range of Support Services in a speculative 1980's office building. The building does not represent a University identity, sits at the geographical centre of the University Quarter, and terminates the vista along Winston Churchill Avenue.

Given its prominent location and height of surrounding buildings the site represents a significant potential for future redevelopment. The capacity of the site as shown is approx 16,500m², effectively doubling the existing GIA, but this could potentially increase, subject to planning policy and rights of light analysis.

The masterplan proposal includes a requirement to include public routes through the development in order to limit pedestrian movement along busy roads, and create a new public courtyard space in the centre. In order to ensure this space is activated it would be important to include public spaces at ground floor whether part of the University, or third party tenancies, further supporting the integration of University and City, and engagement with the wider public.

The planned pedestrianisation of Hampshire Terrace would create the potential for uses on both sides to spill out into the new public realm.

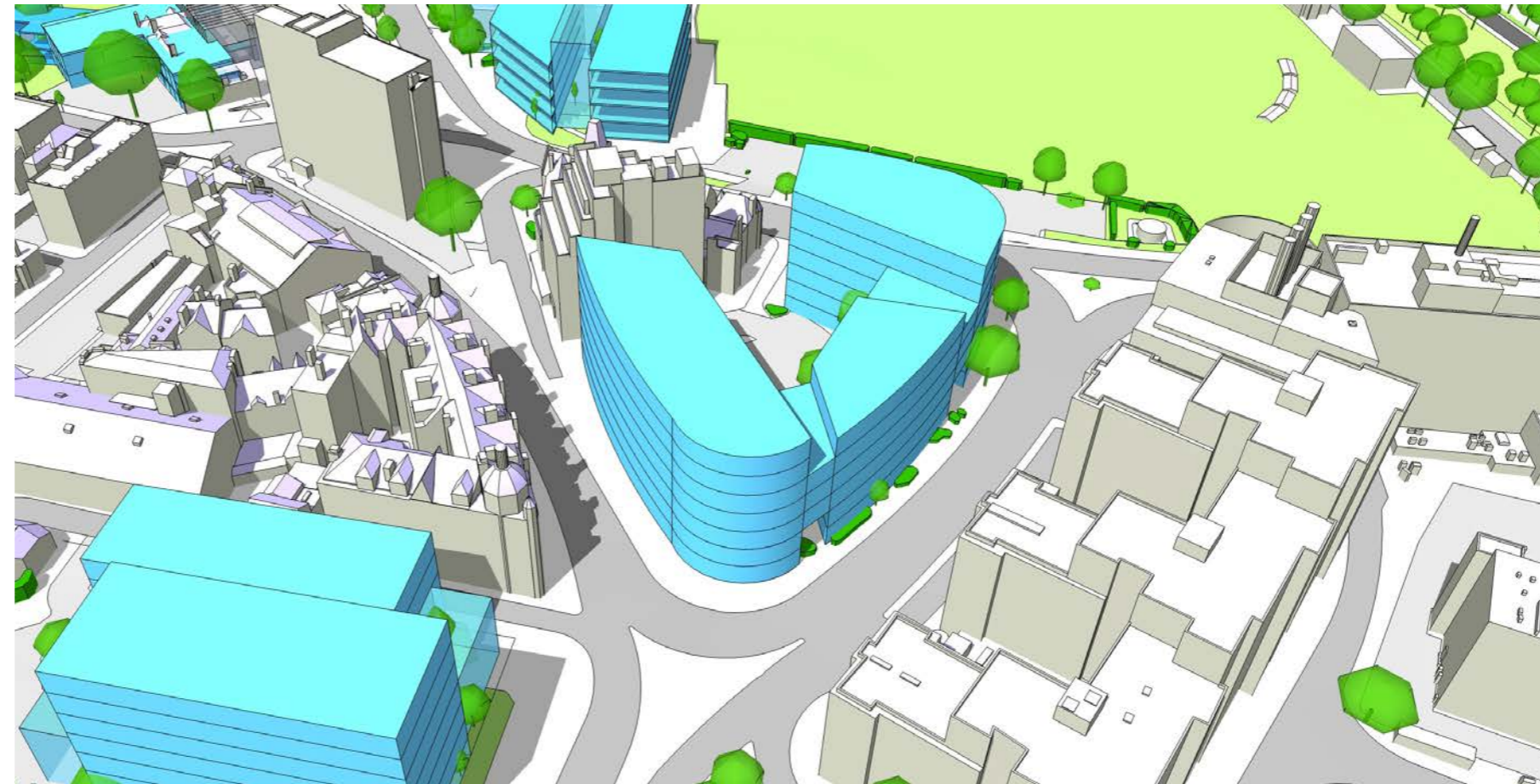

Urban design principles:

- Create a landmark building that terminates views along Winston Churchill Avenue.
- Improve north south pedestrian routes.
- Create active and animated ground floors.
- Improve public realm and the University presence, in particular if Hampshire Terrace is downgraded.
- Create an attractive space within the block. This has the opportunity to provide respite from the busy street environment.



KEY

- 1 New central administration building
- 2 Public court and route through development
- 3 Pedestrianised Hampshire Terrace

4.0 Masterplan Projects

4.2 Central Quarter University House site

The existing University House site presents a long term opportunity to locate a new academic building at the heart of the campus, and help to more closely integrate the Faculty of Creative and Cultural Industries with the rest of the campus.

The existing University House was built as a Building Society HQ and accommodates a number of Support Services and the Directorate. As St Andrew's Court, the building does not present a University identity, and with the potential redistribution of existing functions to the Victoria Park site, Student Hub and refurbished Mercantile House, the site becomes available for a new academic building that can further enhance the presence of the University on this main route into the City.

With the adjacent hotel, this building might also present another opportunity for hosting conferences and special events.

Urban design principles:

- Create a continuity of frontage onto Winston Churchill Avenue.
- Respect the adjacent historic building, by retaining views towards it and stepping down in height.
- Improve the public realm and retain existing trees where possible.

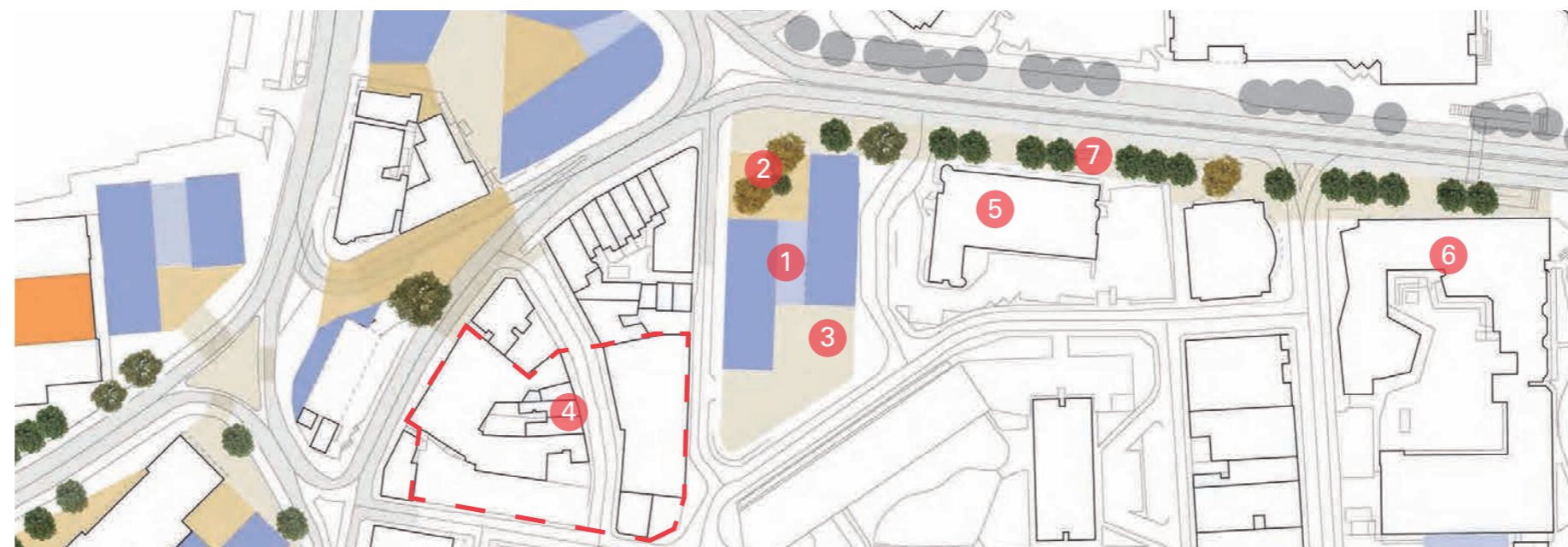

KEY

- 1 New academic building
- 2 Entrance forecourt and public space
- 3 Student route via atrium to Eldon Building
- 4 Potential future integration with Wiltshire/St Paul's site
- 5 Existing hotel
- 6 Eldon Building
- 7 Public realm improvements to Winston Churchill Avenue

4.0 Masterplan Projects

4.2 Central Quarter CCI

CCI has seen significant investment in the Eldon Building to enable the whole Faculty to be consolidated under one roof and the recently completed White Swan Building providing new performing arts facilities to replace the Wiltshire Building.

At the rear of the Eldon Building the surface level car park provides the possibility for future expansion space, with the existing parking either retained with building above, or alternatively, parking re-provided in a multi storey elsewhere on campus.

The capacity of the site is approx 4,500m²

Urban design principles:

- Complete the block and create attractive frontages onto the surrounding streets.

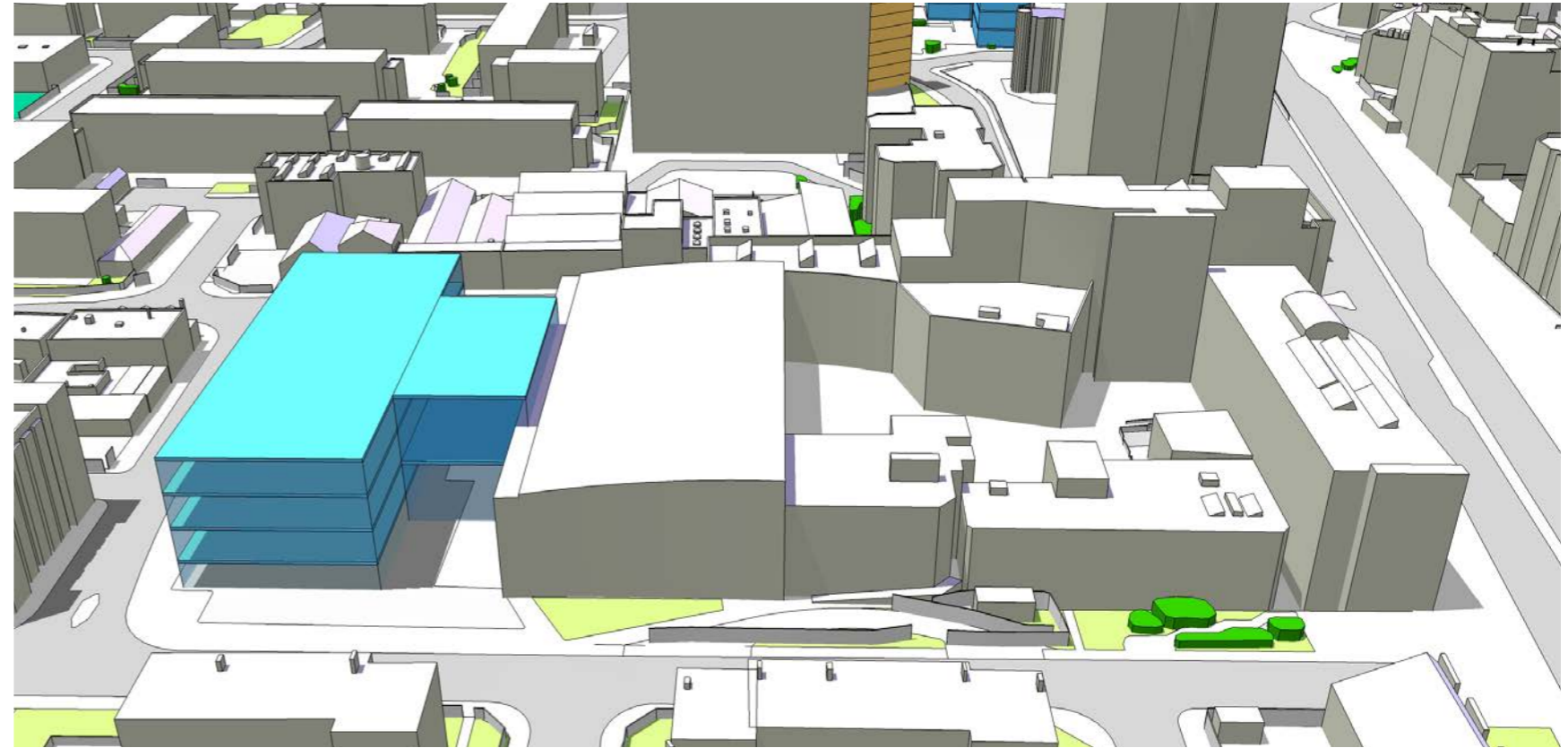

4.0 Masterplan Projects

4.3 Ravelin Park

Ravelin Park is a pleasant green oasis in the heart of this part of the city and is a place where students can meet, study and relax. The Park setting is not only protected in planning policy, but is a precious resource for the University which provides a backdrop for many University and City events.

The masterplan proposals for new student hub and new sports building will enhance and support the existing role that the Park plays in the student experience.

The following pages look at these two projects in more detail.

Urban design principles:

- Improve the quality of the park.
- Strengthen and improve the southern gateway.
- Define focal spaces and distinct zones within the park.
- Improve crossing points towards Ravelin Park and improve and create public pedestrian connections across Ravelin Park.



KEY

- 1 New Student Hub
- 2 Dental Academy
- 3 University Library
- 4 Ravelin House
- 5 New Sports Building



Ravelin Park looking towards Gun House

4.0 Masterplan Projects

4.3 Ravelin Park Student Hub

The University are considering options for a new Student Hub which is seen as a student focussed building with front of house student support services relocated from Nuffield, and other areas. The Hub would also accommodate additional flexible social learning areas.

Mission Statement provided by the University:

To be shared with the the Student's Union, providing a student-centred, vibrant, interactive, social environment for students to engage with seamless, consistent student services through a single place of access; utilising customer care best practices and the latest supporting technology to deliver the experience. To maintain a high profile centre of excellence that enhances the promotion of the SU and the information, support and advice available to students.

Key aspects of emerging brief include:

- Good visibility from road
- Connection to Library to be considered
- SU to be seen as separate entity with significant ground floor presence and defined entrance
- SU committed to an alcohol free venue
- Delivery model will be a hub and spoke model with Faculties continuing to provide course-related information and signposting to central services

The preferred location for the new Student Hub has been agreed as the north end of Ravelin Park, in the location of the existing Student Centre. It is close to the centre of the campus and supports the role of Ravelin Park being at the heart of the student experience, combining sport and recreation, library, student services and student union. Three options for development are under consideration.

The University wishes to increase its Point of Care activities to include:

- Speech Therapy
- Social Work
- Pharmacy
- Radiography
- additional Dental
- Optometry
- Exercise Science

A location adjacent to the existing Dental Academy would suit this function and is therefore accommodating this within the Student Hub building has been included as an option.

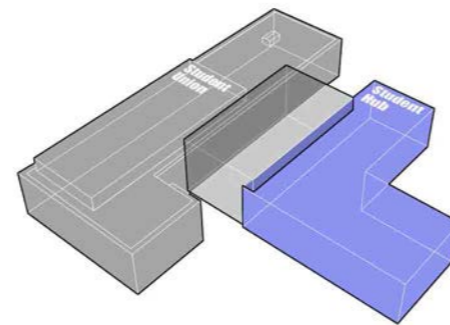
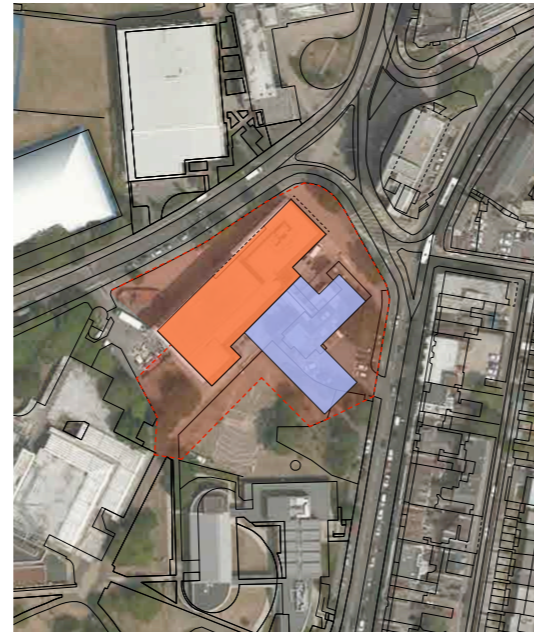

Option 1

Remodel and extend	3550m ²
Extg Student Centre	
New build hub	1500 - 2000m ²

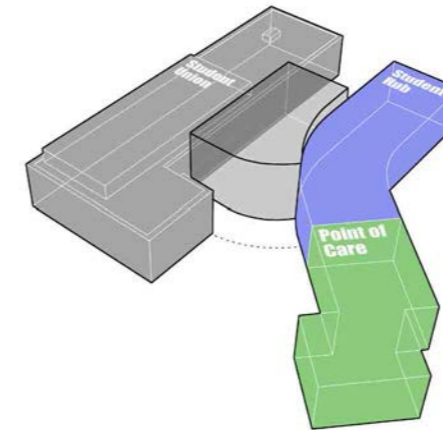
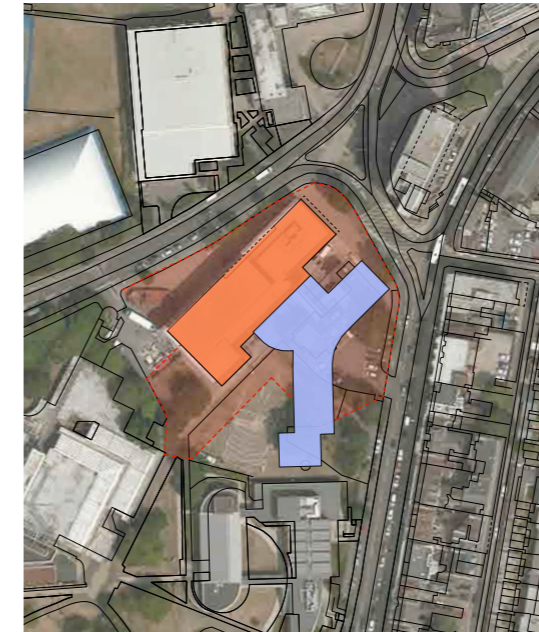

Option 1A

Remodel and extend (plus Pt of Care)	3550m ²
Extg Student Centre	
New build hub	1500 - 2000m ²
Point of Care	approx 900m ²

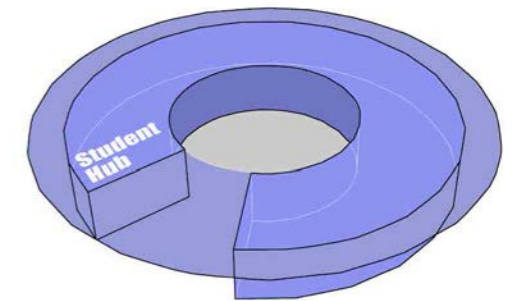
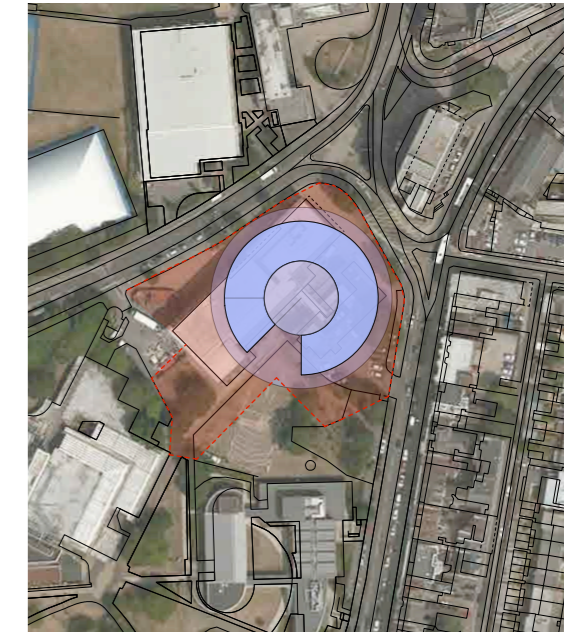

Option 2

Demolish and redevelop	
Total GIA	approx 6000m ²

4.0 Masterplan Projects

4.3 Ravelin Park Student Hub

Urban design principles:

- Create a building that does this prominent corner justice.
- Open up public north south routes through the park and improve pedestrian crossings points.
- Create clearly defined and animated spaces within Ravelin Park – avoid blank frontages and service yards on important pedestrian routes and spaces.



01



02



02



04



05

- 01 Sketch View of Student Hub from Ravelin Park
- 02 Coventry University Hub
- 03 Huddersfield Student Central
- 04 Newcastle Student and Admin Services Building
- 05 London South Bank University Student Hub

4.0 Masterplan Projects

4.3 Ravelin Park New Sports Building

A separate Sports Feasibility Study was prepared by Strategic Leisure which assessed the existing facilities and made recommendations with regards new sports provision. This study has informed this element of the masterplan.

In summary, the conclusion of the report is that the existing demand for facilities and the nature and extent of existing facilities is a compromise, where no-one is completely satisfied. Sports provision is divided across a number of sites, and both the quantity and quality of existing provision falls far short of the University's competitors.

Based on the assessment of current provision, current and future demand for sports facilities at the UoP it is very clear that there is a need to provide both additional sports facilities, and expand the range of facilities provided. Taking this approach would both increase participation which would benefit the overall health of the UoP student community, and generate increased income. The latter could then contribute to off-setting the capital cost of investing in new facilities.

The priority facilities to be included in a new sports building include:

- An 8 court sports hall
- Increased fitness provision – up to 150 fitness stations, plus additional
- Multi-purpose studios (ideally 3)
- An 8 lane x 25m swimming pool
- Watersports facilities
- Extreme sports facilities (indoor and outdoor) – could comprise climbing, cycling, sand sports, Bounce, golf simulator, snooker/pool

Two sites were considered, the site of the Nuffield Centre and the Ravelin Park car park site. The latter was selected as the preferred option for the following reasons:

- Larger site
- Available for development
- Prominent site
- Park setting - good for access to external fitness
- Visibility from Cambridge Road
- Location at end of University campus route

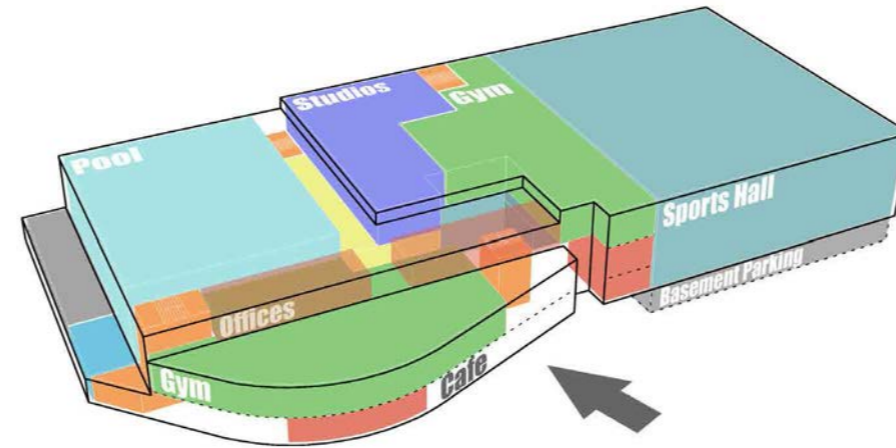

01

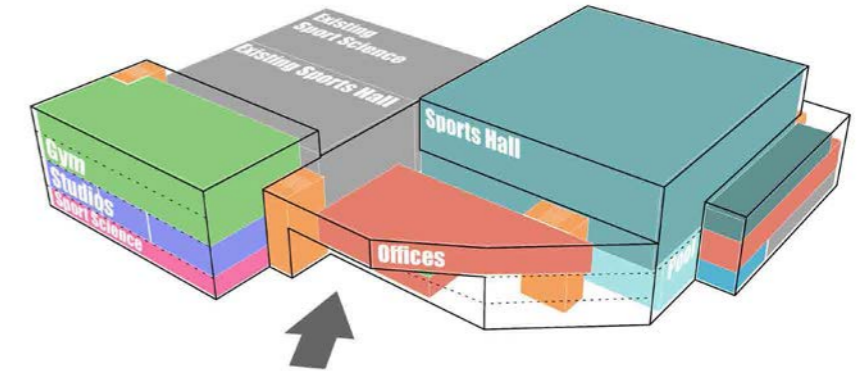

03



02



04

- 01 Ravelin Park site massing
- 02 Ravelin Park site sketch
- 03 Nuffield site massing
- 04 Nuffield site sketch

4.0 Masterplan Projects

4.3 Ravelin Park New Sports Building

In planning terms, the site is covered by policy ST2 (see full policy below in blue) in summary this stipulates that any new proposals will have to preserve the setting of the park. It acknowledges the potential for the site (current parking area) for redevelopment and again stresses the importance of the prominent location. The site also sits next to the Old Portsmouth Conservation area and as such the new building will be expected to be sympathetic with the character of the conservation area and respect the setting of this as well as of the listed buildings next to it.

Proposals to redevelop or extend any parts of the University campus within Ravelin Park must preserve the setting of the park.

Ravelin Park is an important area of greenspace in the central part of the city and is identified as an area of open space to be retained on the Proposals Map. In addition to its use by the University, it provides amenity open space for local residents. The city council will support proposals for increased public access to the park.

The University has relocated its students union, which previously occupied premises in the south west corner of the park, to a new student centre in the north of the park, in order to consolidate university facilities in and around the city centre. This has released the south western site for redevelopment. This site would be appropriate for a variety of university uses. Design will be an important consideration at this prominent location. Any such development must respect the setting of the park, take account of its tree preservation order and be of a sympathetic scale and design to its surroundings.

This project is the subject of a separately commissioned Feasibility Study which will consider the constraints and opportunities of the site in more detail, in particular in relation to the retention of extg tree belts.

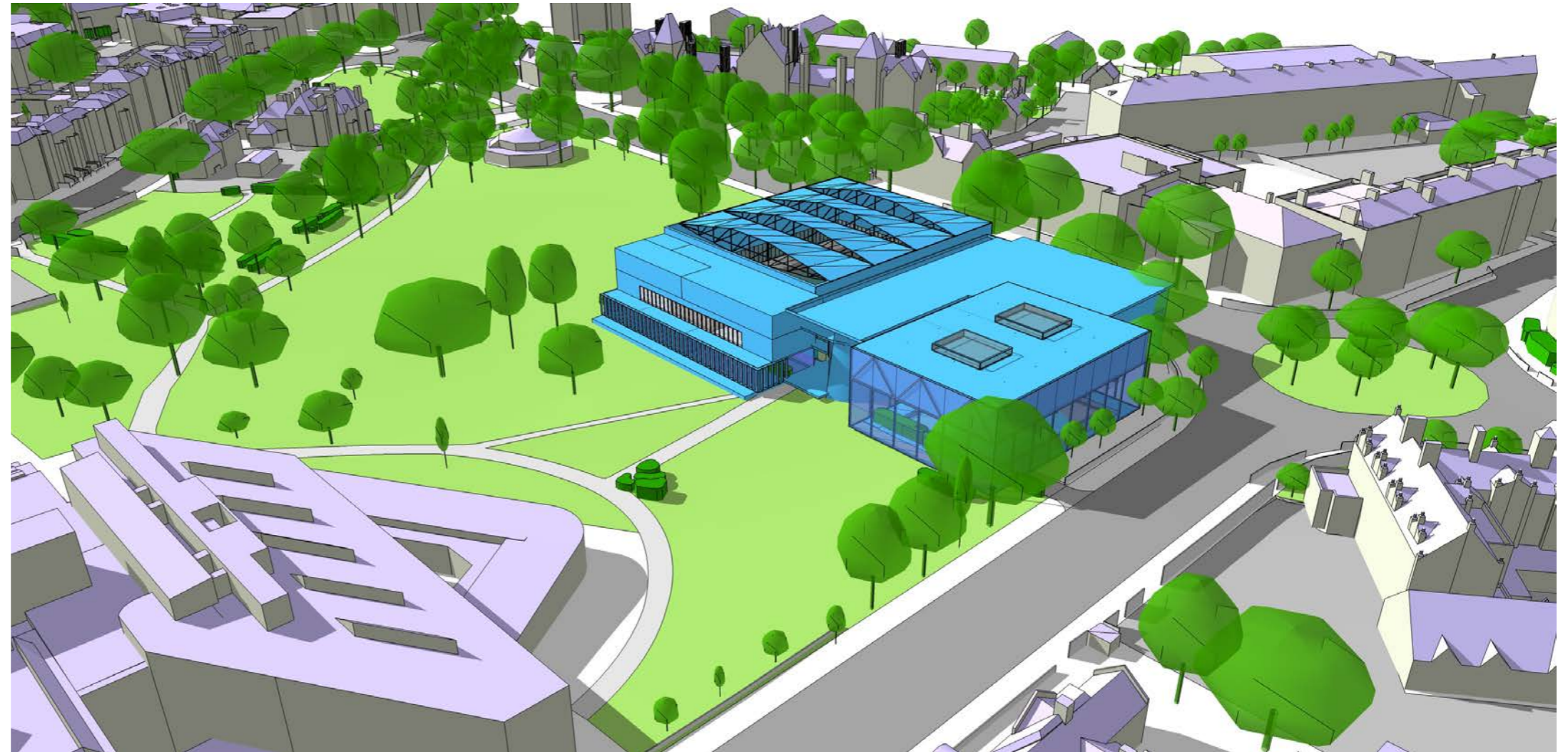

Key urban design issues to consider as include:

Consideration will need to be made as to the visibility into and through the building from Cambridge Road in order to create an active facade, and the main entrance should be clearly visible from Cambridge Road.

Need to address the views from St George's Road and the roundabout. The south-west corner of the building will become an important and visible corner and probably define the sense of arrival into the University Quarter from the south. The design will need to create a quality corner/landmark in this location.

The south elevation of the building would need to be designed as to avoid it becoming a long homogeneous frontage. The current frontage along Museum Road offers movement and variety and the sports building should try (as much as possible) to reflect this, perhaps by providing some breaks along the elevation.

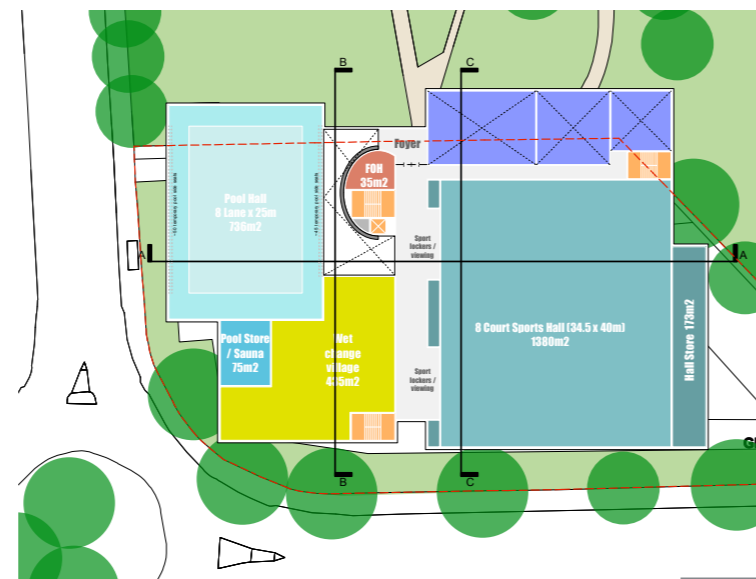

02

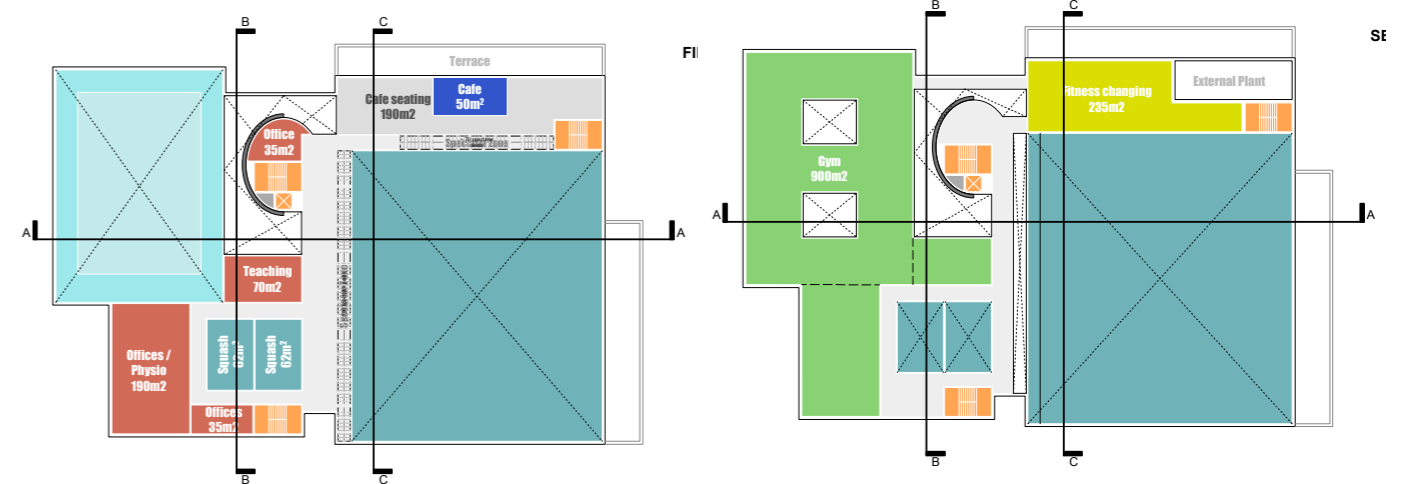

03

04

- 01 Aerial Sketch view
- 02 Ground Floor
- 03 First Floor
- 04 Second Floor

4.0 Masterplan Projects

4.3 Ravelin Park New Sports Building

Urban design principles:

- Relate this building to the sensitivities of the adjacent conservation area, by breaking down the bulk and massing of the sports building, choice of materials and orientation.
- Retain or replace the existing trees to retain a sense of greenery along this edge.
- Animate ground floors and make internal uses, such as sporting activities visible.
- Where possible allow views to the park.
- Improve the junction for pedestrian and cycle crossing.
- Create clearly defined pedestrian route through the park.

Due to the proximity of the conservation area and listed building any design proposals will need to be carefully considered and developed in dialogue with the local planning authority to ensure any concerns are addressed as early as possible within the planning process.



01



02

01 Precedent Images
02 Sketch View from Cambridge Road



UNIVERSITY OF
PORTSMOUTH

